



Jellinbah Group



LAKE VERMONT MEADOWBROOK PROJECT
ENVIRONMENTAL IMPACT STATEMENT
CHAPTER 3 PROJECT DESCRIPTION



Table of Contents

3	Project Description	3-1
3.1	Proposed development	3-1
3.1.1	Project title	3-1
3.1.2	Project objectives and rationale	3-1
3.1.3	Project capital expenditure	3-2
3.1.4	Nature and scale of the Project	3-3
3.1.5	Project timing	3-6
3.1.6	Project location—regional and local context	3-7
3.1.7	Workforce	3-15
3.2	Site description	3-18
3.2.1	Tenure	3-18
3.2.2	Existing infrastructure	3-24
3.2.3	Topography, landforms and catchments	3-28
3.2.4	Geology and economic resources	3-28
3.2.5	Soils and land use	3-35
3.2.6	Protected areas	3-37
3.3	Construction	3-40
3.3.1	Infrastructure corridor	3-41
3.3.2	Access/coal haulage roads	3-41
3.3.3	Mine infrastructure area (MIA)	3-44
3.3.4	Underground drifts and portal	3-46
3.3.5	Ventilation systems	3-47
3.3.6	Electricity supply infrastructure	3-47
3.3.7	Water supply and management infrastructure	3-47
3.3.8	Construction materials and equipment	3-49
3.3.9	Construction disturbance area	3-50
3.4	Operations	3-50
3.4.1	Mine resource, schedule and sequence	3-50
3.4.2	ROM coal handling and processing	3-73
3.4.3	Product coal handling and transport	3-76
3.4.4	Reject management	3-76
3.4.5	Ongoing resource definition and exploration activities	3-77
3.4.6	Hazardous substances	3-77
3.4.7	Operations disturbance areas	3-78
3.5	Infrastructure	3-79
3.5.1	Transport	3-79
3.5.2	Energy	3-80



3.5.3	Telecommunications	3-80
3.5.4	Sewage treatment.....	3-80
3.5.5	Water supply and management.....	3-81
3.6	Project alternatives	3-84
3.6.1	Mining method alternatives.....	3-84
3.6.2	Longwall mining layout and alternatives	3-85
3.6.3	Open-cut mining layout and sequence	3-86
3.6.4	Infrastructure corridor alignment	3-87
3.6.5	Infrastructure and MIA.....	3-87
3.6.6	Workforce accommodation	3-88
3.6.7	Not proceeding with the Project.....	3-89
3.7	Ecologically sustainable development	3-89
3.7.1	Precautionary principle	3-90
3.7.2	Intergenerational equity	3-92
3.7.3	Conservation of biological diversity and ecological integrity.....	3-92
3.7.4	Valuation	3-93

List of Figures

Figure 3.1:	Project location	3-4
Figure 3.2:	Project layout.....	3-5
Figure 3.3:	Brigalow Belt Bioregion.....	3-8
Figure 3.4:	Isaac Connors Sub-catchment of the Fitzroy Basin	3-9
Figure 3.5:	Isaac Connors groundwater management area.....	3-10
Figure 3.6:	Regional planning interest areas.....	3-12
Figure 3.7:	Queensland agricultural land audit—important agricultural area.....	3-13
Figure 3.8:	Native title determinations.....	3-14
Figure 3.9:	Land ownership.....	3-19
Figure 3.10:	Coal tenements	3-22
Figure 3.11:	Petroleum tenements	3-23
Figure 3.12:	Existing road network	3-25
Figure 3.13:	Rail, sea and air transport facilities.....	3-27
Figure 3.14:	Project watercourses and topography.....	3-29
Figure 3.15:	Geology of the Project site.....	3-30
Figure 3.16:	Surface geology of the Project site	3-32
Figure 3.17:	West–east cross-sections of Project geology.....	3-33
Figure 3.18:	North–south cross-section of Project geology.....	3-34
Figure 3.19:	Soil management units for the Project	3-36
Figure 3.20:	IAAs and agricultural and classes within the Project area	3-38
Figure 3.21:	Referable wetlands	3-39
Figure 3.22:	Conceptual cross-sections of the Project access/haulage road.....	3-42
Figure 3.23:	Conceptual designs of the Phillips Creek and One Mile Creek Crossings	3-43
Figure 3.24:	Proposed layout of the mine infrastructure area	3-45
Figure 3.25:	Conceptual diversion drain cross-section	3-49
Figure 3.26:	Indicative mine progression plans—underground mining.....	3-53
Figure 3.27:	Indicative mine progression plan—open-cut pit mining.....	3-54
Figure 3.28:	Lake Vermont Meadowbrook Complex—life of mine production profile	3-55
Figure 3.29:	Mine stage plan—Project Year 2.....	3-56
Figure 3.30:	Mine stage plan—Project Year 7.....	3-57



Figure 3.31: Mine stage plan—Project Year 12..... 3-58

Figure 3.32: Mine stage plan—Project Year 17..... 3-59

Figure 3.33: Mine stage plan—Project Year 22..... 3-60

Figure 3.34: Mine stage plan—Project Year 27..... 3-61

Figure 3.35: Mine stage plan—end of all mining 3-62

Figure 3.36: Longwall Mining Method Schematic..... 3-63

Figure 3.37: SIS Gas Drainage Underground Installation Example. 3-65

Figure 3.38: Example SIS gas drainage relocatable skid..... 3-66

Figure 3.39: Example venturi skid equipment. 3-67

Figure 3.40: Example flare installation..... 3-68

Figure 3.41: Vertical goaf gas wells—example installation..... 3-69

Figure 3.42: Post-closure flood model in relation to open-cut infrastructure..... 3-72

Figure 3.43: CHPP module schematic 3-75

Figure 3.44: Lake Vermont Mine infrastructure 3-76

List of Tables

Table 3.1: Overview of the Lake Vermont Meadowbrook Complex..... 3-15

Table 3.2: Landholders underlying and/or adjacent to the Project..... 3-20

Table 3.3: Coal and petroleum tenements 3-21

Table 3.4: Bowen Basin regional stratigraphy 3-31

Table 3.5: MIA Dam sizing 3-48

Table 3.6: Approximate disturbance areas associated with construction..... 3-50

Table 3.7: Provisional mine schedule—annual coal and waste production 3-51

Table 3.8: Major underground equipment and mobile fleet..... 3-64

Table 3.9: Major open-cut mining equipment list 3-74

Table 3.10: Indicative list of hazardous substances..... 3-78

Table 3.11: Disturbance associated with Project operations 3-79



3 Project Description

3.1 Proposed development

3.1.1 Project title

The title of the Project is the Lake Vermont Meadowbrook Project.

The Project provides for the continuation and extension of the existing Lake Vermont Mine to maintain existing production levels over an extended mine life. Mining tenements and tenures relevant to the Project are described in section 3.2.1.

3.1.2 Project objectives and rationale

The objective of the Project is to develop the metallurgical coal resource located to the north and directly adjoining the existing Lake Vermont Mine to secure the long-term future of the operation.

The Project addresses the forecast reduction in coal production that will occur at the existing Lake Vermont Mine by combining output from the existing open-cut operations and the Project extension. The Project extension proposes underground mining development, as well as a new satellite open-cut pit. The Project will enable total coal production to be maintained at the currently approved output for an extended period of approximately 20 years, with the overall Project life spanning approximately 53 years (inclusive of final rehabilitation). Proposed Project mining and production rates are detailed in section 3.4.1.

The existing Lake Vermont Mine extracts approximately 11.5 to 12 Mtpa of run-of-mine (ROM) coal to produce approximately 9 Mtpa of product coal. Mining activity at the existing Lake Vermont Mine will gradually decline from 2023, with further sharp decreases (to approximately 4 Mtpa and less) from 2028 until the end of the mine life (currently scheduled for 2061). The Project, therefore, proposes to provide additional product coal to augment the reduced open-cut output, thereby maintaining production levels at approximately 9 Mtpa from 2028 through to 2048. Following completion of the Project underground extension in 2048, the proposed open-cut pit will supplement the existing operations, albeit with production levels continuing to tail off until Project mining completion in 2055. Final mining completion at the existing Lake Vermont Mine will still occur in 2061. Proposed Project mining and production rates are detailed in section 3.4.1.

Other key objectives of the Project are:

- to continue to operate profitable mining operations that provide high-quality hard coking coal, PCI coal and industrial coal for export markets;
- to maximise recovery of economically mineable coal resources within Bowen Basin Coal's mining tenements;
- to design, construct and operate the expanded mine to minimise impacts on the social and natural environments;
- to maximise the use of Bowen Basin Coal-owned land and existing infrastructure at the Lake Vermont Mine to minimise the environmental impacts from additional infrastructure and provide Project efficiencies; and
- to comply with all relevant statutory obligations and continue to improve processes to achieve sound environmental management.

The Project will provide ongoing employment opportunities for workers currently employed at the Lake Vermont Mine. It will also allow Bowen Basin Coal to continue to support local and regional suppliers of the operations by providing additional security and longevity of employment in the region.

The Queensland metallurgical coal industry is a significant supplier to international markets by providing the global steel manufacturing industry with high-quality hard coking coal and PCI coal. In 2019, the Lake Vermont



Mine contributed 8.9 Mt to the export market and was ranked as the ninth largest supplier to the export coal market (Queensland Government 2022).

The Project is ideally positioned to efficiently meet the market demands for metallurgical coal by having access to the Lake Vermont Mine's existing infrastructure. The Project will maximise the use of this existing infrastructure to minimise environmental impacts from additional infrastructure. Existing infrastructure that will be utilised includes:

- the Lake Vermont Mine Coal Handling and Preparation Plant (CHPP);
- coal handling facilities;
- train load-out facilities;
- product coal stockpiles;
- co-disposal coal reject facilities; and
- other supporting infrastructure.

3.1.3 Project capital expenditure

The total capital expenditure for the construction of the Project (to full production) is estimated at \$750 million. This capital expenditure includes the construction of:

- an infrastructure corridor running from the Lake Vermont Mine infrastructure area, which will comprise:
 - an access and coal haulage road;
 - an overhead 66 kV electricity transmission line (ETL);
 - a raw water supply pipeline; and
 - telecommunications infrastructure;
- a mine infrastructure area (MIA), which will include:
 - administrative and operational office facilities;
 - workshop, warehouse and equipment washdown and laydown areas;
 - electrical substation and electrical distribution infrastructure;
 - ROM coal stockpile area and associated infrastructure;
 - mine water dams; and
 - mine entry portals and main ventilation shaft and fans (refer to section 3.4 for further details);
- underground mining equipment; and
- a refurbishment and extension of the Lake Vermont Accommodation Village in Dysart.

The Economic Impact Assessment (Chapter 19, Economics; and Appendix Q, Economic Impact Assessment) conducted for the Project indicates the Project would have significant revenue benefits for the Commonwealth, State and Local Governments through royalties and other taxation. Operation of the Project is anticipated to contribute a net present value of approximately \$968.2 million to the Queensland economy. Over the life of the Project, it is estimated to provide approximately \$1,919.4 million of additional tax revenues to the Australian Government, and approximately \$1,334.5 million to the Queensland Government as compared to what would occur without the Project (Appendix Q, Economic Impact Assessment, Section 5.4 and Section 8.3).

The Project will contribute to economic growth through increased industry output and Gross Regional Product (GRP) during construction and operation, as well as decommissioning and rehabilitation flowing from both direct and indirect impacts.



The Project is estimated to support an additional:

- \$146.3 million in GRP per annum in the regional catchment during construction;
- \$33.6 million in GRP per annum in the regional catchment during capital replacement activities; and
- \$315.7 million GRP per annum in the regional catchment during peak operations.

3.1.4 Nature and scale of the Project

The Lake Vermont Mine is an existing open-cut mining operation. The Project is a proposed metallurgical coal development that provides for the continuation and extension of the Lake Vermont Mine, to the north of the existing operations, within the proposed Mining Lease Application (MLA) area (refer Figure 3.1). Approved open-cut mining operations at the existing Lake Vermont Mine (within mining lease [ML] 70331, ML 70477 and ML 70528) will occur concurrently with the development and operation of the Project.

The Project includes underground single and dual-seam longwall mining, open-cut mining activities and development of supporting infrastructure. The Project will enable the future Lake Vermont Complex (existing Lake Vermont Mine + proposed Project) to maintain production at approximately 9 Mtpa (of product coal) from 2028 through to 2048, with the overall lifespan of the combined Project along with the existing open-cut operations being approximately 53 years (inclusive of final rehabilitation). Mining and production numbers are detailed in section 3.4.1.

Approximately 108.6 Mt of underground ROM coal plus 13.3 Mt of open-cut ROM coal is estimated to be mined over the life of the Project, producing approximately 122 Mt of total ROM coal.

The proposed underground longwall and open-cut mining areas are shown in Figure 3.2. The depth of the coal resources and thickness of the coal seams across the Project are such that underground longwall mining provides the most effective method of extraction. The underground mine will target the Vermont Lower Seam in the southern portion of the underground resource area and both the Vermont Lower and Leichhardt Lower Seams in the northern portion of the underground resource area. Approximately 108.6 Mt of ROM coal is estimated to be mined by underground mining methods.

A small open-cut is planned to mine shallower resources not amenable to underground mining. The open-cut pit will be mined as a “satellite” pit to the existing Lake Vermont Mine and use traditional truck and excavator methods. Mining within the open-cut pit has been designed to minimise the disturbance associated with waste rock emplacements, with partial backfilling of the mined pit supported by smaller out-of-pit waste rock emplacements. Approximately 13.3 Mt of ROM coal is estimated to be mined from the proposed open-cut pit.

The Project proposes the development of the following infrastructure on the existing Bowen Basin Coal tenements (MLs and MDLs):

- an infrastructure corridor linking the new mining area to existing infrastructure at the Lake Vermont Mine to provide for access, coal haulage, power and water supply and telecommunications infrastructure for the new mining activities;
- an MIA (described in detail in section 3.3.3);
- underground portal, drifts and shafts for underground operations;
- boreholes to support the delivery of materials to the underground operations; and
- gas drainage bores and associated surface infrastructure.

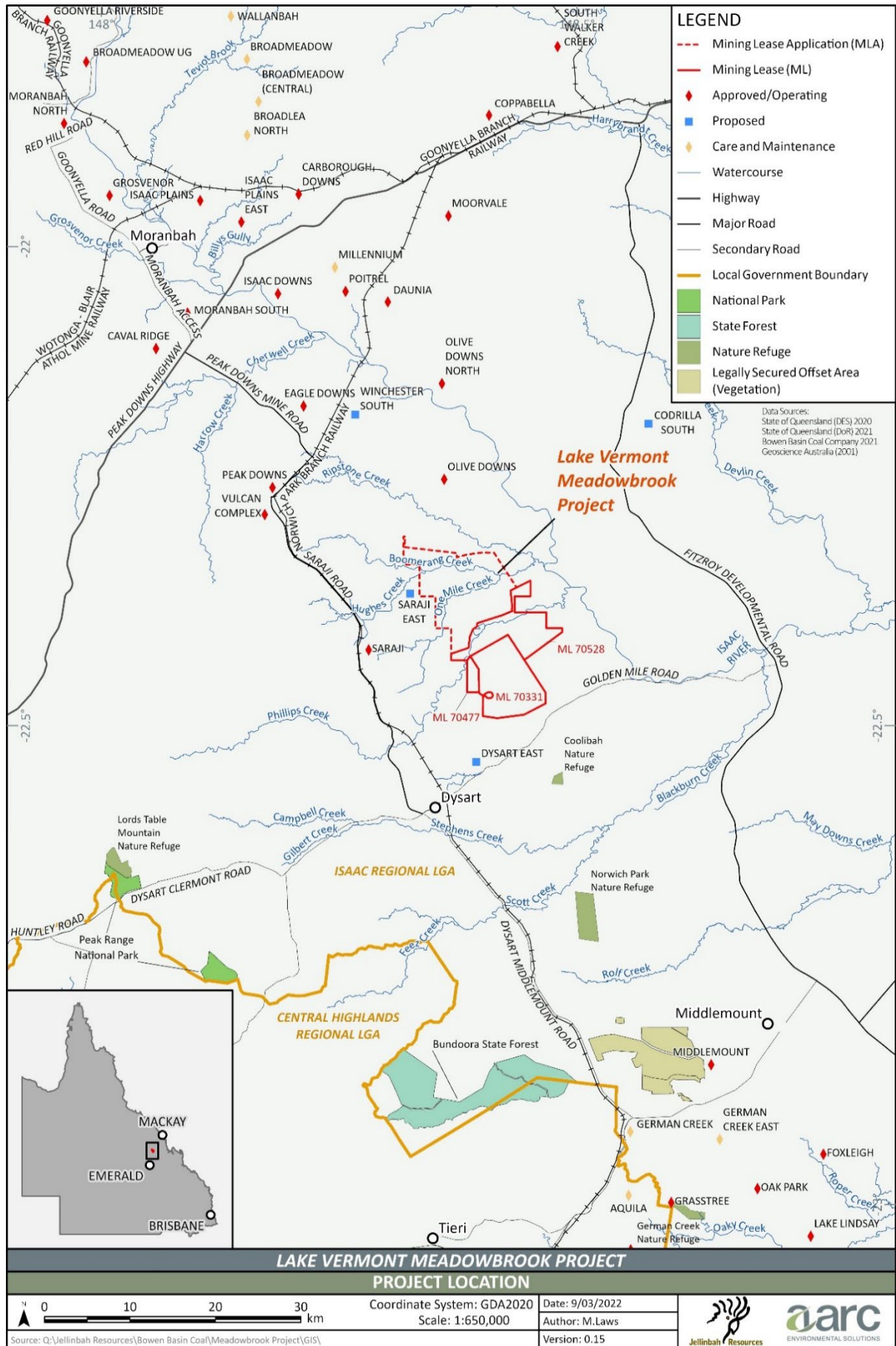

Figure 3.1: Project location

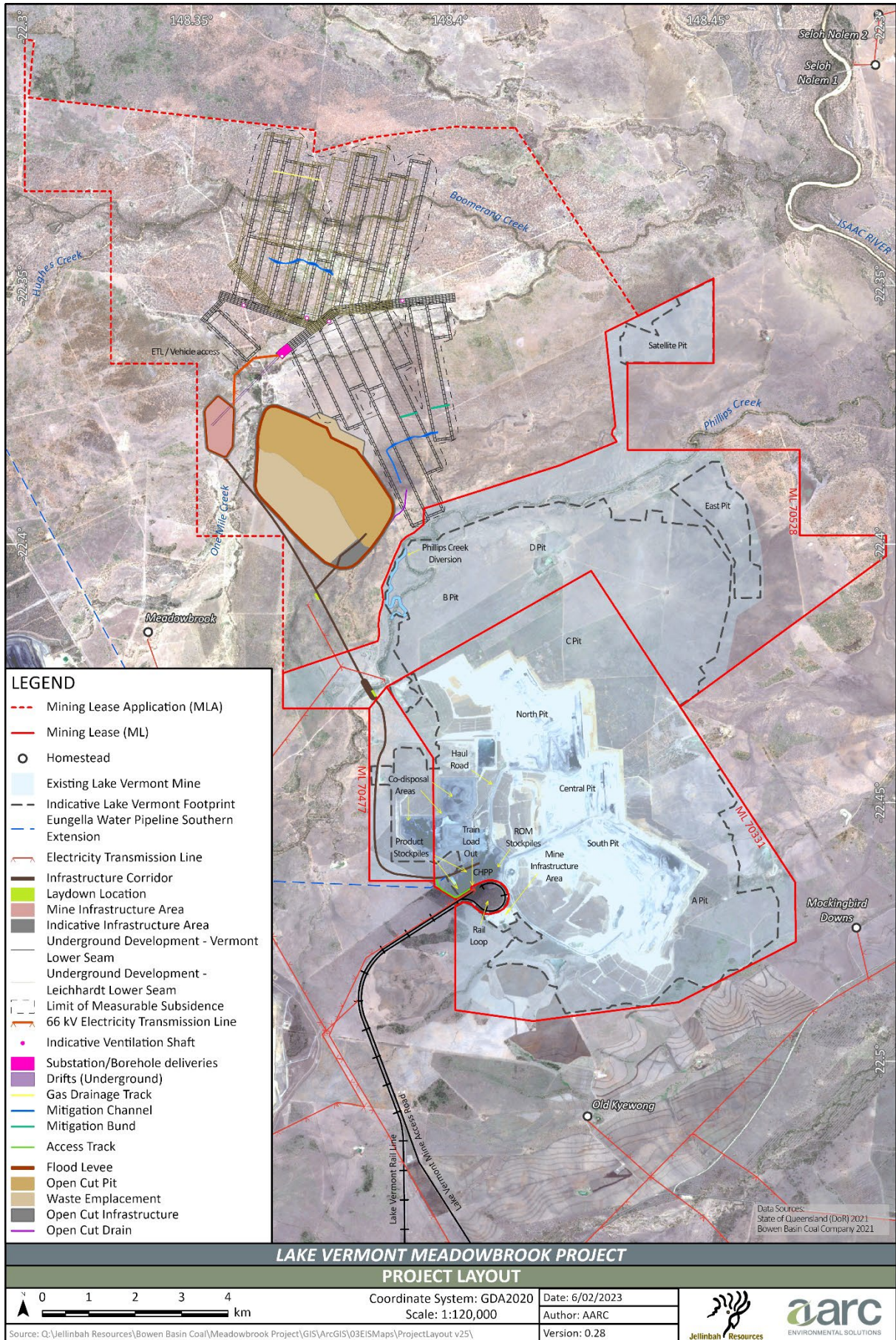

Figure 3.2: Project layout



As described in Chapter 1, Introduction, the arrangement of the Project (as shown in Figure 3.2) utilises existing infrastructure and facilities at the Lake Vermont Mine to minimise Project disturbance. The Project will utilise:

- the existing CHPP;
- coal handling facilities;
- train load-out facilities;
- product coal stockpiles;
- co-disposal coal reject facilities; and
- other supporting infrastructure.

Handling of CHPP rejects will continue, in accordance with current management practices, by utilising existing and approved reject co-disposal areas at the Lake Vermont Mine supported by future in-pit-disposal. Mine reject management is detailed further in Chapter 6, Rehabilitation, section 6.5.5.

Product coal will continue to be railed *via* the Goonyella and Blackwater Rail System to the RG Tanna Coal Terminal in Gladstone, the Abbot Point Coal Terminal in Bowen or the Dalrymple Bay Coal Terminal in Mackay for sale to export markets. The Project schedule has been developed to integrate with the ongoing development of the approved Lake Vermont Mine.

The Project underground and open-cut mining operations will be undertaken within the MLA area, which covers an area of approximately 8,238 ha. The area proposed to be directly disturbed by the Project is 827.8 ha, primarily comprising disturbance to support the development of the infrastructure corridor, the MIA, and Project open-cut mining area. The Project open-cut mining area accounts for 666.4 ha of the total direct disturbance. A further 15.3 ha of the total direct disturbance is proposed within the existing Lake Vermont leases, to support the southern connection of the infrastructure corridor to the existing Lake Vermont Mine infrastructure area. The area expected to be indirectly disturbed (through subsidence-induced ponding impacts and associated mitigation measures) is 214.0 ha. Disturbance will be staged in accordance with the scheduled Project activities. Assessment of Project disturbance is undertaken through Chapter 10, Terrestrial Ecology and Chapter 21, Matters of National Environmental Significance.

All land to be disturbed by mining activities is owned by Bowen Basin Coal Pty Ltd (the Proponent) and will be rehabilitated to achieve a post-mining land use. Rehabilitation will occur progressively throughout the mine life in accordance with the Progressive Rehabilitation and Closure Plan (PRCP) that has been developed for the Project. The draft PRCP for the Project is provided in Appendix B, Progressive Rehabilitation and Closure Plan. Queensland's *Environmental Protection Act 1994* (EP Act) and the 'Mined Land Rehabilitation Policy' have been considered in the design of all phases of the Project, and rehabilitation of the Project will occur accordingly.

No new off-lease infrastructure is required by the Project; however, works will occur at the existing Lake Vermont Accommodation Village to upgrade and extend these facilities. Proposed works at the Lake Vermont Accommodation Village in Dysart are described in section 3.1.7.6. These proposed works are required to enable more efficient operation and maintenance of the accommodation village and will be subject to separate approval from the Isaac Regional Council (IRC) in accordance with the Queensland *Planning Act 2016* and Council's applicable planning schemes.

The environmentally relevant activities (ERAs) and notifiable activities applicable to the Project are described in section 1.5.2.3 in Chapter 1, Introduction.

3.1.5 Project timing

Construction and mine development activities are scheduled to commence subject to and following the approval of the proposed amendments to the environmental authority (EA) and granting of the ML.

Project Years are referenced throughout this environmental impact statement (EIS) in preference to relating milestones to calendar years. This facilitates uncertainties associated with future approval timings—in other words, should the Project commence later than anticipated, Project Years will remain relevant, whereas calendar years will not.



For consistency throughout this EIS, construction for the underground extension is forecast to commence in fiscal Year 2024 (being Project Year -1) and will continue for a period of approximately 24 months (throughout Project Year -1 and Project Year 0). Details of proposed construction activities are provided in section 3.3.

In-seam development of the underground headings up to the commencement of longwall extraction will be undertaken in Project Year 1 and Project Year 2, with the commencement of longwall mining operations commencing in Project Year 3.

Mining of the Project open-cut satellite pit will not commence until Year 20, and will have a life of 11 years.

The combined underground and open-cut resource areas will support a production life of approximately 30 years—commencing in Year 1 (indicatively 2026) and completing in Year 30 (indicatively 2055). Details of the proposed schedule of operations, including production quantities, mining progression and stage plans, are provided in section 3.4.1.

Progressive rehabilitation will occur throughout the life of the Project, with final rehabilitation and achievement of a stable post-mining land use (grazing) anticipated in Project Year 53 (indicatively 2078). Further details of the rehabilitation and closure of the Project is provided in Chapter 6, Rehabilitation.

3.1.6 Project location—regional and local context

3.1.6.1 Regional context

The Project is located approximately 25 km north-east of Dysart and approximately 160 km south-west of Mackay, within the IRC LGA (Figure 3.1 and Figure 3.3).

The Project is characterised by the following:

- It is within the Brigalow Belt North Bioregion, as defined by the 'Interim Biogeographic Regionalisation for Australia' (DoEE 2016) (Figure 3.3).
- It is approximately 50 km to the north-east of the Peak Range National Park—protected areas, such as national parks and nature refuges, near the Project are shown in Figure 3.1.
- It is within the Isaac Connors Sub-catchment of the Fitzroy Basin, as defined by the 'Water Plan (Fitzroy Basin) 2011' (Figure 3.4).
- It is within the Isaac Connors Groundwater Management Area (Figure 3.5) and a portion of the Project within the Isaac Connors Alluvium Groundwater Sub-area, as declared under the 'Water Plan (Fitzroy Basin) 2011'. The Project is not within or proximate to the Great Artesian Basin.
- It is outside of zones mapped as Priority Living Areas, Priority Agricultural Areas, Priority Development Areas and Strategic Environmental Areas under the *Regional Planning Interests Act 2014* (RPI Act) (Figure 3.6). The Project contains a small area mapped as potential SCL under the RPI Act (referred to as SCL trigger area on Figure 3.6).
- It is on some land mapped as an *Important Agricultural Area* by the 'Queensland Agricultural Land Audit' (Figure 3.7).
- It is within land zoned as *Rural* under the 'Isaac Regional Planning Scheme' (IRC 2021) and land zoned as *Regional Landscape and Rural Production Area* under the 'Mackay, Isaac and Whitsunday Regional Plan' (DLGP 2012). A small area of the Project is on land mapped as *good quality agricultural land* in the 'Mackay, Isaac and Whitsunday Regional Plan' (DLGP 2012). The area mapped as good quality agricultural land is consistent with the SCL trigger area mapped under the RPI Act near the proposed infrastructure corridor.
- It is within the Barada Barna People (QC2012/007) Native Title application area but not within the Barada Barna People's Native Title Determination. The Barada Barna People are the native title holders of the general Project region (Figure 3.8). Native title has been extinguished over all land within the MLA area and does not form part of the Barada Barna People's Native Title Determination.



Figure 3.3: Brigalow Belt Bioregion

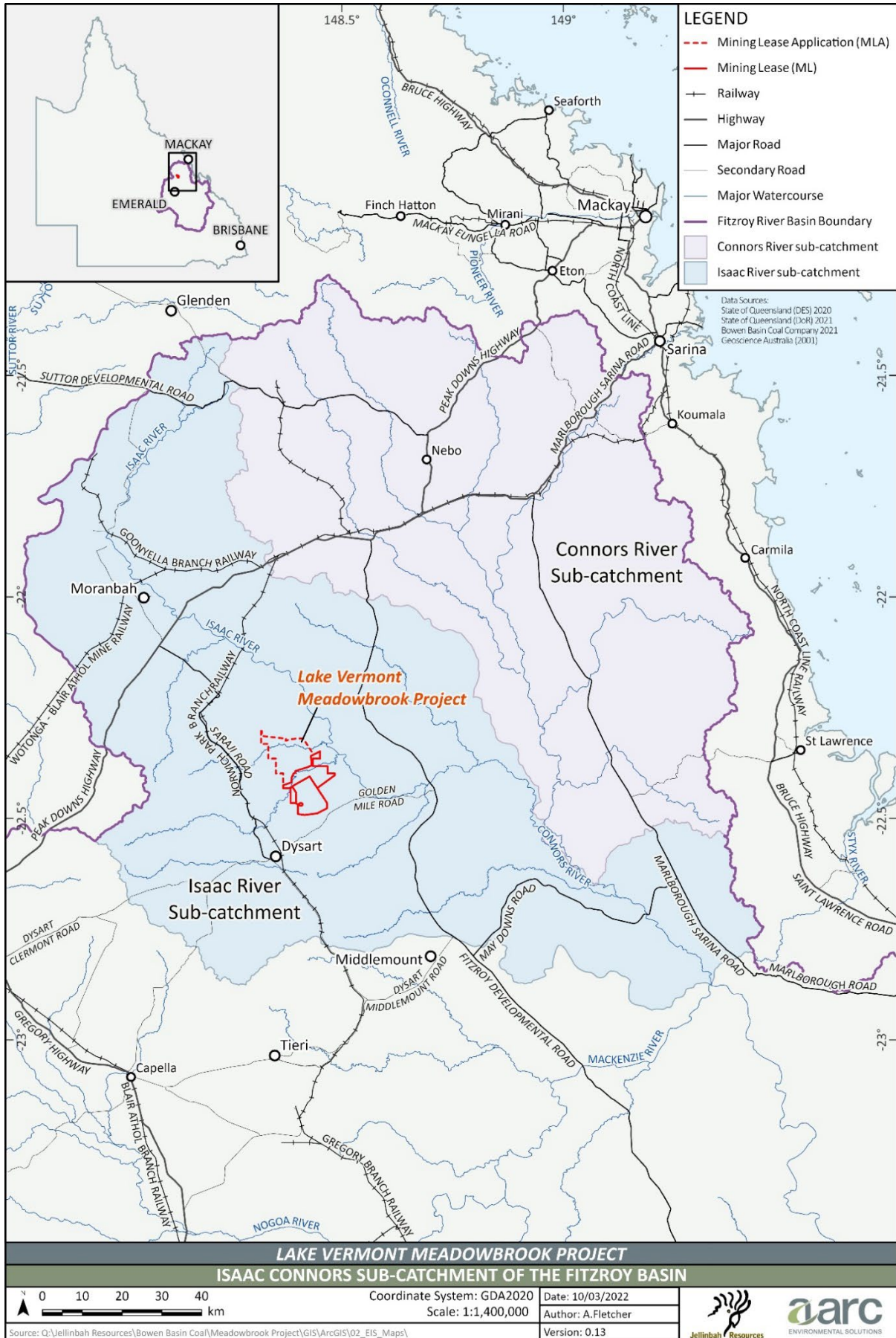

Figure 3.4: Isaac Connors Sub-catchment of the Fitzroy Basin

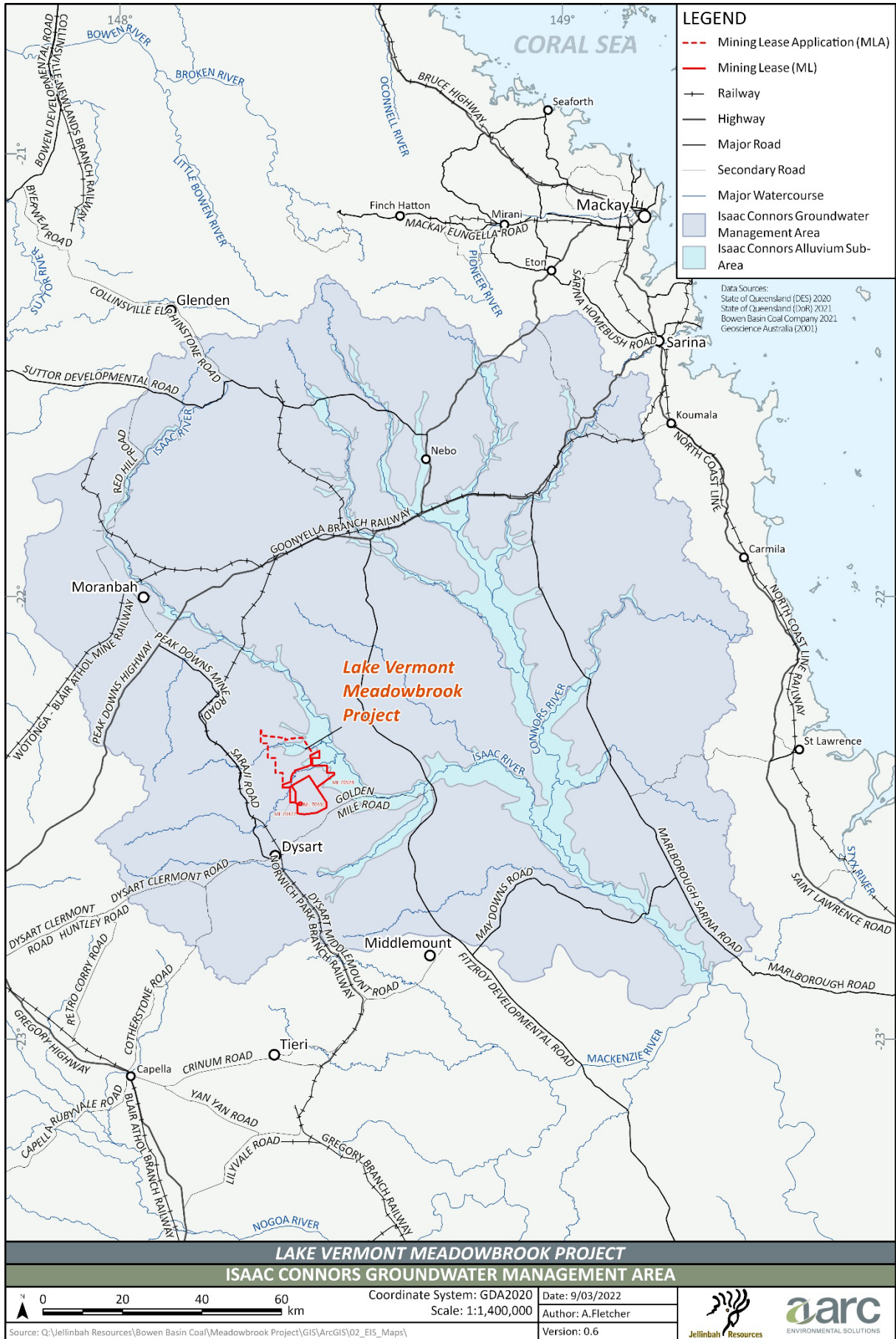

Figure 3.5: Isaac Connors groundwater management area



The Project is located within Queensland's highly productive Bowen Basin, an area rich in coal and gas deposits (Figure 3.1). Existing (i.e. approved) and proposed nearby coal mining operations include (Figure 3.1):

- Saraji Mine approximately 5 km to the west;
- Saraji East Project (proposed) on land adjoining the western boundary of the Project;
- Olive Downs approximately 2 km to the north and Olive Downs North approximately 40 km to the north;
- Winchester South Project (proposed) approximately 8 km to the north-northwest;
- Eagle Downs approximately 13 km to the north-west;
- Vulcan Complex approximately 20 km to the north-west;
- Peak Downs approximately 25 km to the north-west;
- Daunia approximately 35 km to the north;
- Caval Ridge approximately 45 km to the north-west;
- Poitrel approximately 35 km to the north;
- Millennium approximately 40 km to the north;
- Isaac Downs approximately 40 km to the north-west;
- Moranbah South approximately 45 km to the north-west; and
- Isaac Plains East and Isaac Plains East expansion approximately 50 km to the north-west.

3.1.6.2 Local context

The Project is an extension to the immediate north of the existing Lake Vermont Mine, which operates within ML 70331, ML 70477 and ML 70528 under EA EPML00659513 (Figure 3.2). The existing Lake Vermont Mine is not within the scope of this EIS, and Lake Vermont Resources will continue to undertake open-cut mining operations and related activities at the Lake Vermont Mine in accordance with the terms of its existing approvals.

The land within the MLA is currently used for beef cattle grazing and resource exploration activities. A number of ephemeral watercourses, including Boomerang Creek, One Mile Creek and Phillips Creek, flow in an easterly direction across the Project site towards the Isaac River (Figure 3.1).

Land ownership, easements, reserves and resource tenements in the vicinity of the Project are described in section 3.2. The Proponent owns all the land within the MLA. The BHP Mitsubishi Alliance's (BMA's) Saraji Mine and proposed Saraji East Project are to the immediate west of the Project, while Pembroke's Olive Downs Mine is to the north, and Whitehaven Coal's proposed Winchester South Project is to the north-west. Petroleum tenements for the Arrow Bowen Gas Project overlaps the Project, as described in section 3.2.1.3.

Dysart is approximately 25 km to the south-west of the Project, which is where the Lake Vermont Accommodation Village is situated.

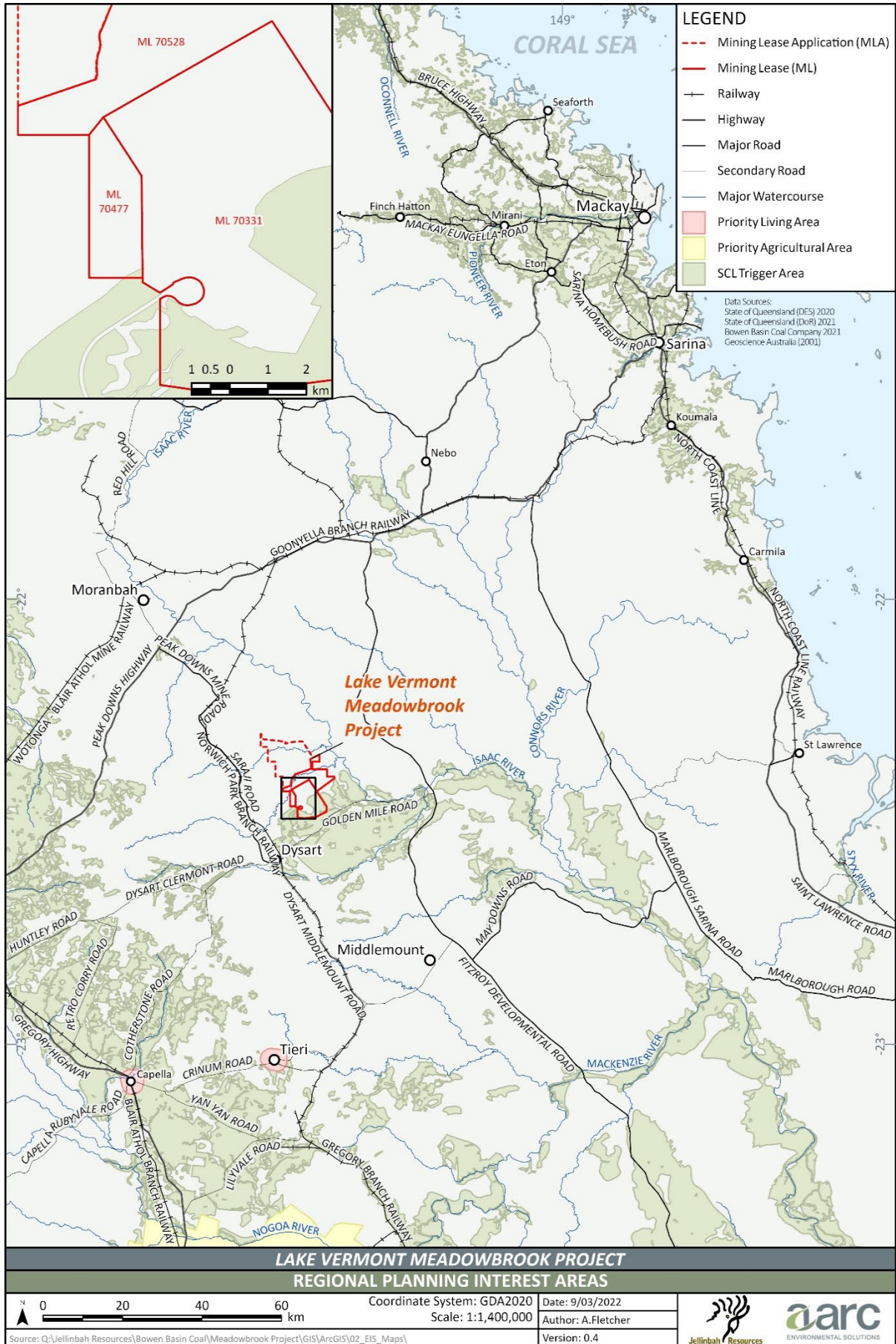

Figure 3.6: Regional planning interest areas

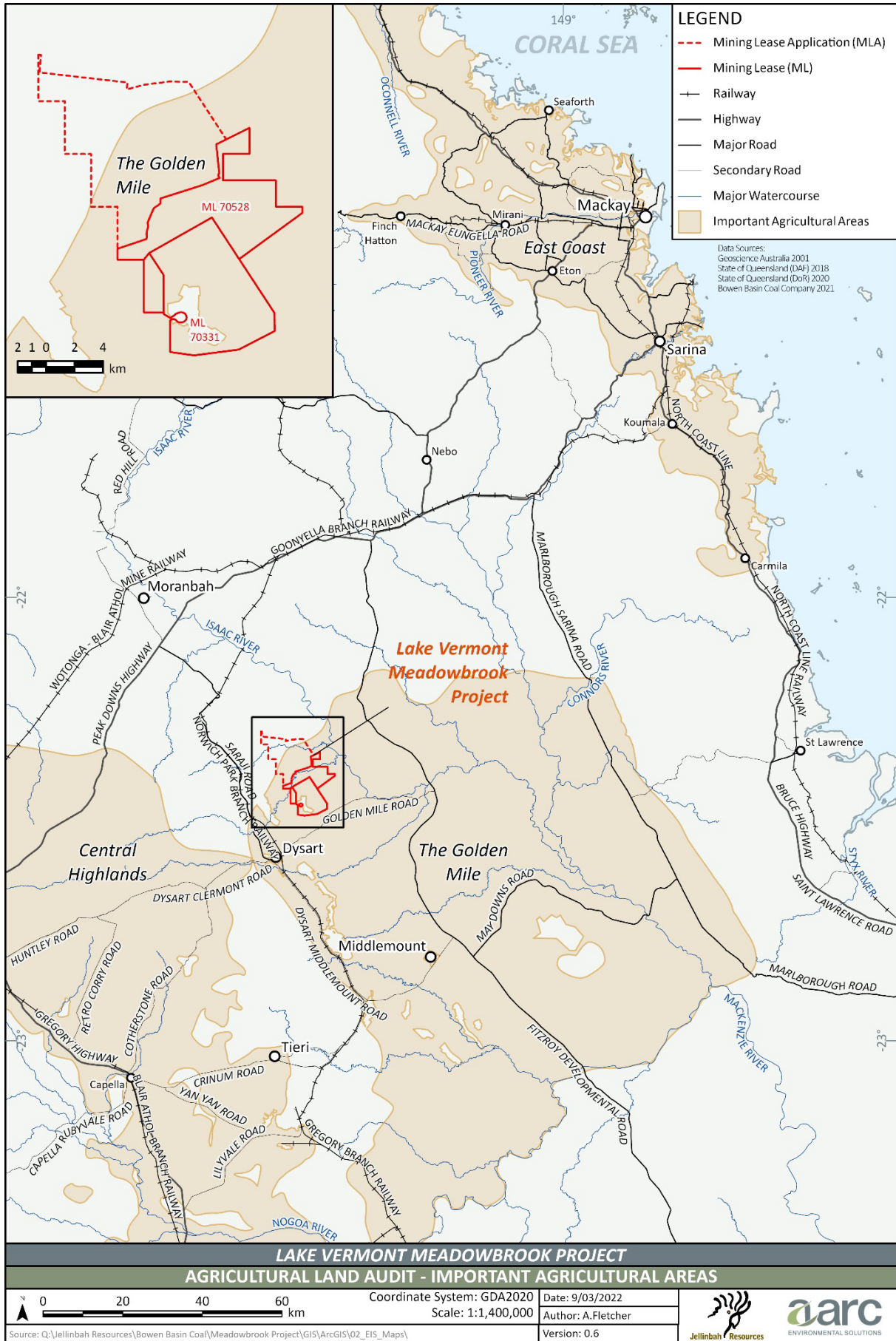

Figure 3.7: Queensland agricultural land audit—important agricultural area

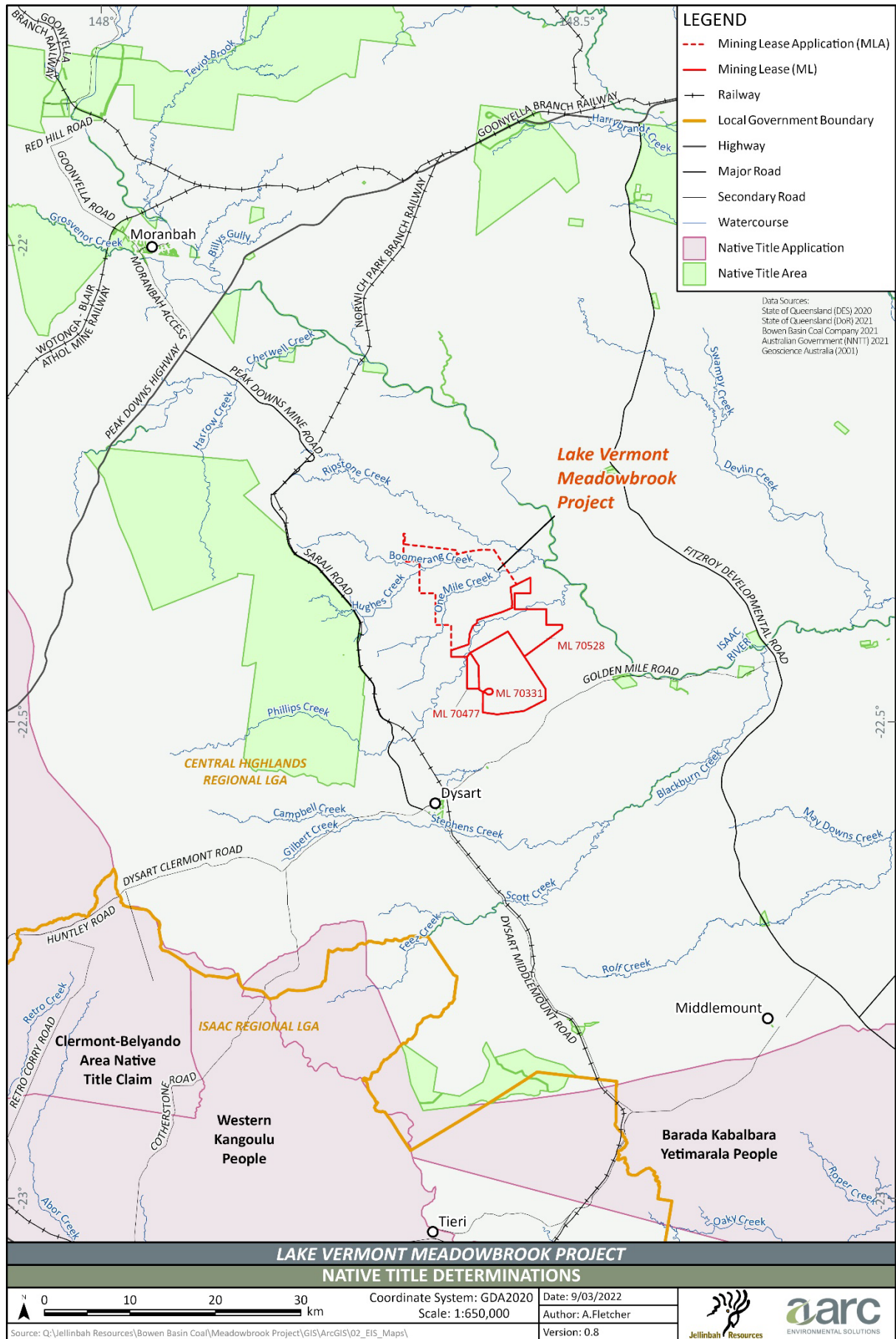

Figure 3.8: Native title determinations



3.1.7 Workforce

3.1.7.1 Construction workforce

A construction workforce of up to 250 personnel is expected during the Project construction phase.

The main workforce categories include:

- civil works;
- site buildings and infrastructure construction;
- drift and shaft construction; and
- equipment assembly.

Occupations represented in the construction workforce are likely to include:

- earthmoving and heavy equipment operators;
- structural steel and welding trades workers;
- geologists, project managers, safety officers, engineers and environmental scientists;
- carpenters, scaffolders, painting, plumbing and electrical trades workers;
- concreters; and
- construction, mine tunnelling and mining labourers.

3.1.7.2 Operational workforce

Approximately 880 people are currently employed at the Lake Vermont Mine. The current workforce is estimated to decrease to 450 people post-2028 as a direct result of the forecast reduction in open-cut coal production (Table 3.1).

At Project full development, the operational workforce for the Lake Vermont Mine Complex (i.e. operation of the existing Lake Vermont Mine together with the proposed Project) is estimated to be 860 workers (450 workers associated with open-cut operations and 410 workers associated with underground operations). Were the Project not to proceed, some 410 direct workforce positions would be lost, plus there would be flow-on indirect economic impacts primarily to Dysart as well as nearby towns (Table 3.1).

Table 3.1: Overview of the Lake Vermont Meadowbrook Complex

Project	Type	Owner (Proponent)	Manager	Operator (principal contractor)	Operational workforce	
					FY20/21	From FY7/28
Lake Vermont Mine	Open-cut mine	Bowen Basin Coal Pty Ltd	Lake Vermont Resources	Thiess Pty Ltd	880	450
Lake Vermont Meadowbrook Project (the Project)	Underground mine, with one small-scale open-cut satellite pit			Contractor and owner personnel	0	410
Lake Vermont Meadowbrook Complex					880	860



The Project will provide training opportunities for the current workforce to transition from the planned reduction in open-cut operations to the underground Project. This will enable workforce retention and job security for those existing employees who wish to take advantage of this opportunity.

Occupations required by the Project during operations are anticipated to include:

- underground heavy equipment operators;
- drillers;
- boiler makers, electricians, special mechanics and diesel fitters;
- engineers, surveyors, geologists;
- health, safety, environment, human resources and mine management professionals; and
- administrative staff.

3.1.7.3 Workforce management

Project workforce management practices will include:

- prioritising recruitment of suitable workers from local and regional communities and workers who have a preference to live in regional communities (*via* a recruitment hierarchy); and
- supporting the health and wellbeing of the Project workforce.

The following recruitment hierarchy will be implemented for the Project:

- Scheduling of recruitment advertising will be staggered, with employment opportunities to be advertised *via* local and regional channels in the first instance, such as CQ Job Link. CQ Job Link is a partnership between the Central Highlands Regional Council and the IRC, with the support of the Local Buying Foundation, providing a free online platform to connect employers and jobseekers in the Bowen Basin region.
- A project information office will be established at the existing Accommodation Village in Dysart during Project Years 1–3, and a dedicated website will be created so that interested local residents can enquire about opportunities and make an appointment for a face-to-face meeting.
- There will be financial incentives for new workers or existing workers on FIFO arrangements to relocate to Dysart (regardless of whether they are employed by Jellinbah or a contractor).
- No job opportunities will be advertised as FIFO-only positions to fully comply with the *Anti-Discrimination Act 1991* and the *Strong and Sustainable Resource Communities Act 2017* (SSRC Act).
- Local industry service providers and jobseekers will be provided with timely notification regarding potential Project employment opportunities.
- The Barada Barna People and Department of Seniors, Disability Services and Aboriginal and Torres Strait Islander Partnerships–Central Region (Rockhampton office) will be consulted in relation to employment and training opportunities for Indigenous people.
- The Project will provide equal opportunities for employment and will recruit based on candidates' skills, skill requirements and job suitability without regard to gender, age, race or disability status.
- As a component of its recruitment strategy, the Project's equal employment opportunity and local employment focus will be promoted to surrounding communities, including under-represented groups, to encourage local participation in the Project.
- Training opportunities will be provided at the Project to attract unskilled and semi-skilled local employees and may include traineeships, apprenticeships and/or general on-the-job training.



3.1.7.4 Rostering

Project construction activities will be undertaken in parallel with ongoing mining operations at the Lake Vermont Mine. Surface construction activities will generally be undertaken during the day, seven days a week. Drift and shaft sinking activities will operate 24 hours per day, seven days per week. Construction rosters are expected to be based on 12-hour shifts.

Throughout the operations phase of the Project, hours will be 24 hours a day, seven days a week. Operational employees will work industry standard 12-hour shifts on seven-day roster cycles. Senior management will most typically work on a five-day on (Monday to Friday) and two-day off roster.

3.1.7.5 Workforce travel arrangements

Given the specialised nature of the work to be completed during the construction phase and its temporary nature, it has been assumed that Mackay, Rockhampton and Gladstone will provide approximately 95% of the construction workforce. The remaining 5% will be sourced from Dysart, Moranbah and other towns within the area.

The Proponent's existing principal contractor, Thiess, has been successfully operating the Lake Vermont Mine and the Lake Vermont Accommodation Village since the commencement of operations in 2009. While preference has been given to employment of local personnel and monetary incentives have been provided to attract employees to reside in Dysart, the majority of the workforce have chosen not to reside in Dysart.

Based on historical and current workforce statistics from the existing Lake Vermont Mine operation, it is expected that within the operating phase of the Project, the following situations may apply:

- Approximately 8% of the workforce will choose to reside in Dysart. An additional 2% will reside in surrounding local communities, such as Moranbah, Middlemount and Clermont. However, these employees will stay in the Lake Vermont Accommodation Village while rostered on, as the daily commute distances from the surrounding local communities to the Project site are in excess of one hour's travel time and will not meet fatigue management requirements.
- Approximately 90% of the workforce will DIDO primarily from the Mackay and Rockhampton regions and reside in the Accommodation Village.

3.1.7.6 Workforce accommodation

The Lake Vermont Accommodation Village in Dysart provides accommodation for the existing Lake Vermont Mine workforce who do not live locally or live locally but choose to stay in the village during their roster. The accommodation village currently has 637 single accommodation units and recreation and dining facilities on-site for guests.

The construction workforce for the Project will be accommodated in either the commercial *Civeo* or *Stayover by Ausco* accommodation village in Dysart.

Consultation with the IRC has been undertaken to discuss the intention of Bowen Basin Coal to upgrade and extend the existing Lake Vermont Accommodation Village for employees who do not choose to live locally. Jellinbah Group (a related entity of Bowen Basin Coal) has acquired land adjacent to the Lake Vermont Accommodation Village to enable extension of the village by up to an additional 100 rooms, while also providing additional parking space. These extension and refurbishment works are required to ease existing parking congestion and continue upkeep maintenance at the village. A development application will be lodged with the IRC for the proposed extension. It is proposed that the extension works would be completed prior to the Project operations phase commencing.



3.2 Site description

3.2.1 Tenure

3.2.1.1 Land ownership

The operational land for the Project is shown on Figure 3.9 and comprises:

- Lot 102 on SP310393 owned by Bowen Basin Coal is to the immediate north of the existing Lake Vermont Mine.
- Lot 1 on SP190747 owned by Marubeni Coal, Jellinbah Group, Coranar (Australia) and CHR Vermont being a related entity to the Proponent is the land upon which the existing Lake Vermont Mine is located.

Properties underlying and adjacent to the Project's operational land are listed in Table 3.2 and shown in Figure 3.9.

3.2.1.2 Easements and reserves

Easement parcels situated within Lot 102 on SP310393 or Lot 1 on SP190747 include (as per Figure 3.9):

- Lot H on SP260662, which is associated with the Vermont Road, traverses Lot 102 on SP310393 in an east–west direction. There is no constructed road within the road easement.
- Lot F on SP206112, which is associated with the Eungella Water Pipeline Southern Extension that supplies raw water to the Lake Vermont Mine.
- Lot H on SP193815, Lot C on SP271130 and Lot D on SP271130, which is associated with the Lake Vermont Mine electricity transmission line and 66 kV/22 kV Lake Vermont substation that provides power to the Lake Vermont Mine.

Several easements also occur on land adjacent to the Project (as per Figure 3.9) including easement parcels associated with the:

- Eungella Water Pipeline Southern Extension;
- Goonyella System Railway;
- Lake Vermont Balloon Loop;
- Lake Vermont Mine Access Road; and
- electricity transmission lines.

No stock routes, state forests, national parks or conservation tenure are within or on land adjacent to the Project.

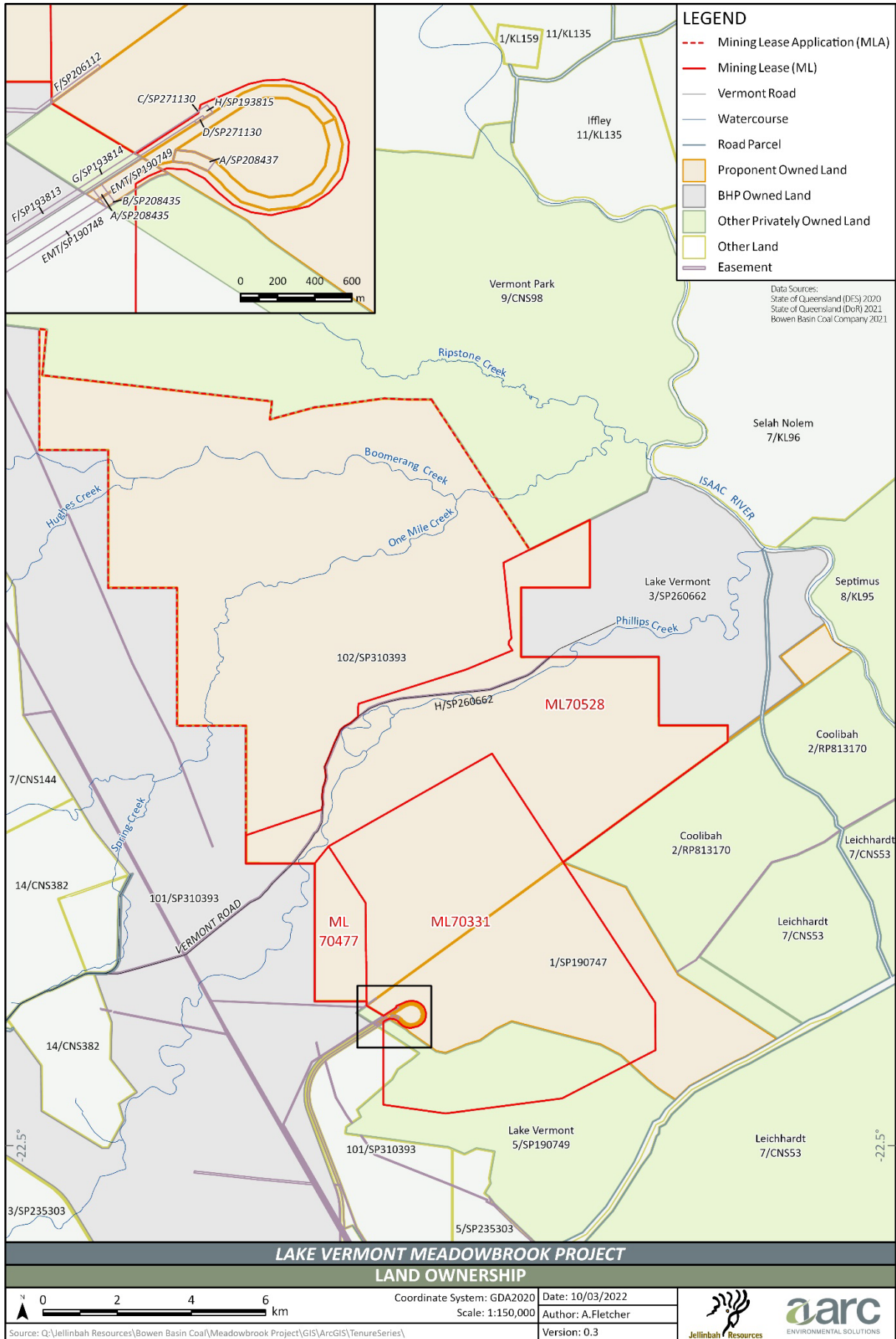

Figure 3.9: Land ownership



Table 3.2: Landholders underlying and/or adjacent to the Project

Landholder	Property description (Lot/Plan)	Tenure	Description
Bowen Basin Coal	102 on SP310393	Freehold	Part of the former “Meadowbrook” property on which the Project is located.
Marubeni Coal, Jellinbah Group, Coranar (Australia), CHR Vermont	1 on SP190747	Freehold	“Mockingbird Downs” on which the existing Lake Vermont Mine is located.
Bowen Basin Coal	1 on SP190749, 2 on SP190747	Freehold	Goonyella System Railway and Lake Vermont Balloon Loop.
Bowen Basin Coal	2 on SP190749	Freehold	The Lake Vermont Mine Access Road.
Private Landholder	5 on SP190749	Freehold	“Lake Vermont” property—the Lake Vermont Mine is located on a portion of this property.
Private Landholder	9 on CNS98	Freehold	“Vermont Park”.
BHP Coal Pty Ltd	101 on SP310393	Freehold	Saraji Mine/Saraji East Project.
BHP Coal Pty Ltd	3 on SP260662	Freehold	“Lake Vermont”.
Private Landholder	8 on KL95	Freehold	“Septimus”.
Private Landholder	2 on RP813170	Freehold	“Coolibah”.
Private Landholder	7 on CNS53	Freehold	“Leichhardt”.

3.2.1.3 Resource tenements

The coal and petroleum resource tenements that either overlap or are adjacent to the Project are listed in Table 3.3 and shown in Figure 3.10 and Figure 3.11.

The Project is an extension to the existing Lake Vermont Mine that operates within ML 70331, ML 70477 and ML 70528 (Figure 3.10). The proposed Project extension footprint lies within MDL 303 and MDL 429 (Figure 3.10). All of these tenements are held by the Proponent who will submit a Mining Lease Application (MLA) over MDL 303 and MDL 429 as part of the approvals required to authorise this Project. Native title has been extinguished over all land the subject of the MLA.

Exploration Permits for Coal (EPC) 837 and 850 held by other coal resource companies overlap a portion of Lot 102 on SP310393 or Lot 1 on SP190747 (Figure 3.10 and Table 3.3); however, they do not overlap the Project. A number of EPC’s under the ownership of third parties (EPC 747, EPC 721, EPC 688, EPC 1444) also overlap lots adjacent to the Project.

Petroleum Authority to Prospect (ATP) tenements ATP 1103 and ATP 1031 overlap Lot 102 on SP310393 and/or Lot 1 on SP190747 (Figure 3.11 and Table 3.3). ATP 814 is also adjacent to the Project (and held under third party ownership); however, these tenements do not overlap the Project. No geothermal tenure or greenhouse gas tenements overlap or are adjacent to the Project site.

Owners of relevant resource tenements are identified through Table 3.3.



Table 3.3: Coal and petroleum tenements

Authorised tenement holder	Tenement number	Location in relation to the Project
Coal tenements		
Bowen Basin Coal	ML 70331, ML 70477, ML 70528, MDL 303, MDL 429, MDL 3001	Overlying Lot 102 on SP310393 or Lot 1 on SP190747
Aquila Exploration Pty Ltd	MDL 519	Adjacent to Lot 102 on SP310393
Pembroke Olive Downs Pty Ltd	ML 700033, ML 700034, MDL 3012, MDL 3013, MDL 3014	Adjacent to Lot 102 on SP310393
BHP Coal Pty Ltd	MLA 70383, MDL 454, EPC 1444 EPC 837	Adjacent to Lot 102 on SP310393 or Lot 1 on SP190747 A portion of EPC 837 overlaps Lot 1 on SP190747 and is on the adjacent lot
Anglo Coal (German Creek) Pty Ltd	EPC 747	Adjacent to Lot 1 on SP190747
Peabody BB Interests Pty Ltd	EPC 721, EPC 688	Adjacent to Lot 102 on SP310393
Peabody BB Interests Pty Ltd	EPC 850	Adjacent and overlaps a portion of Lot 102 on SP30393
Petroleum tenements		
CH4 Pty Ltd	ATP 1103	Overlying Lot 102 on SP310393 and Lot 1 on SP190747
Bow CSG Pty Ltd	ATP 1031	Overlying Lot 102 on SP310393 and Lot 1 on SP190747
Eureka Petroleum Pty Ltd	ATP 814	Adjacent to Lot 102 on SP310393

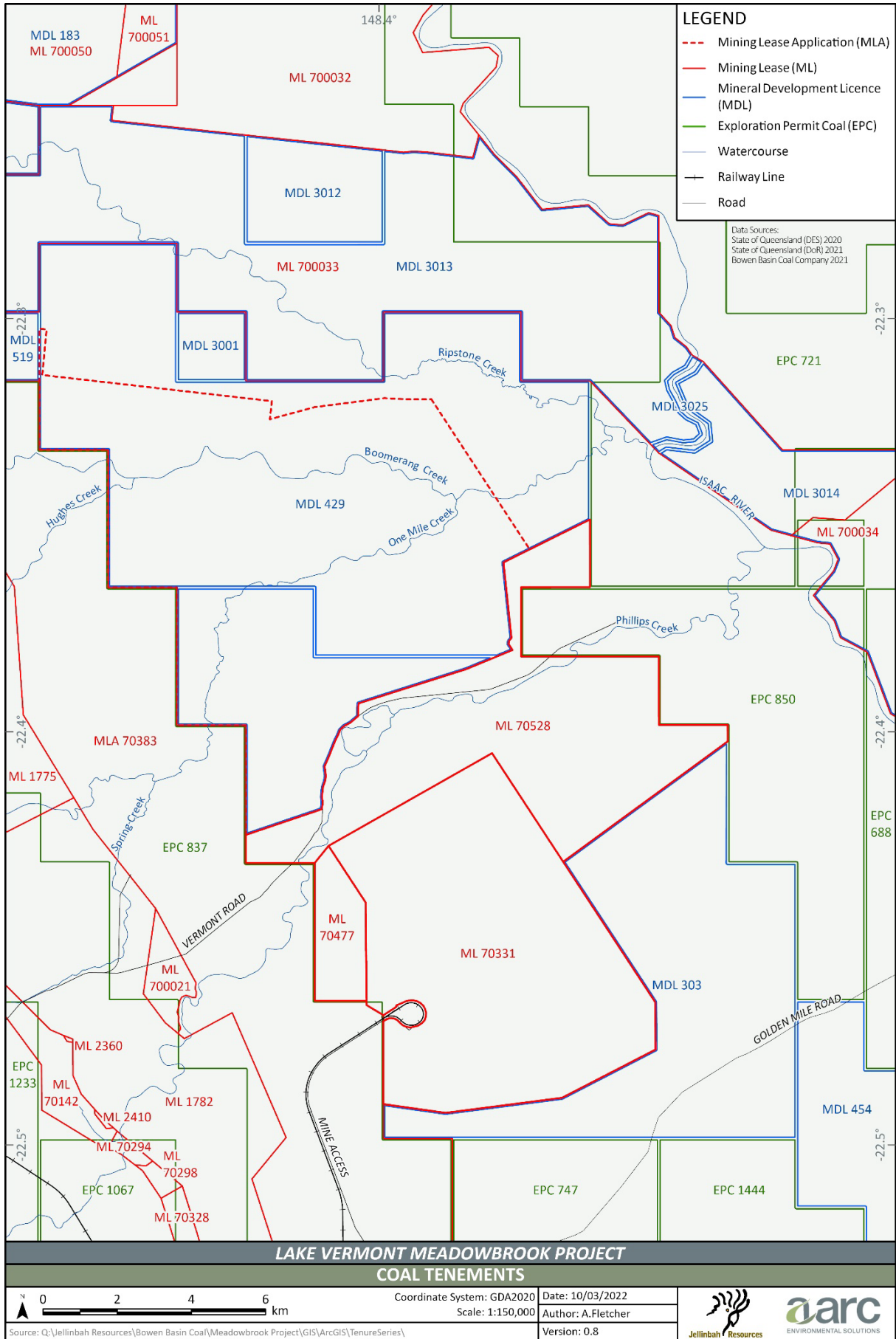

Figure 3.10: Coal tenements

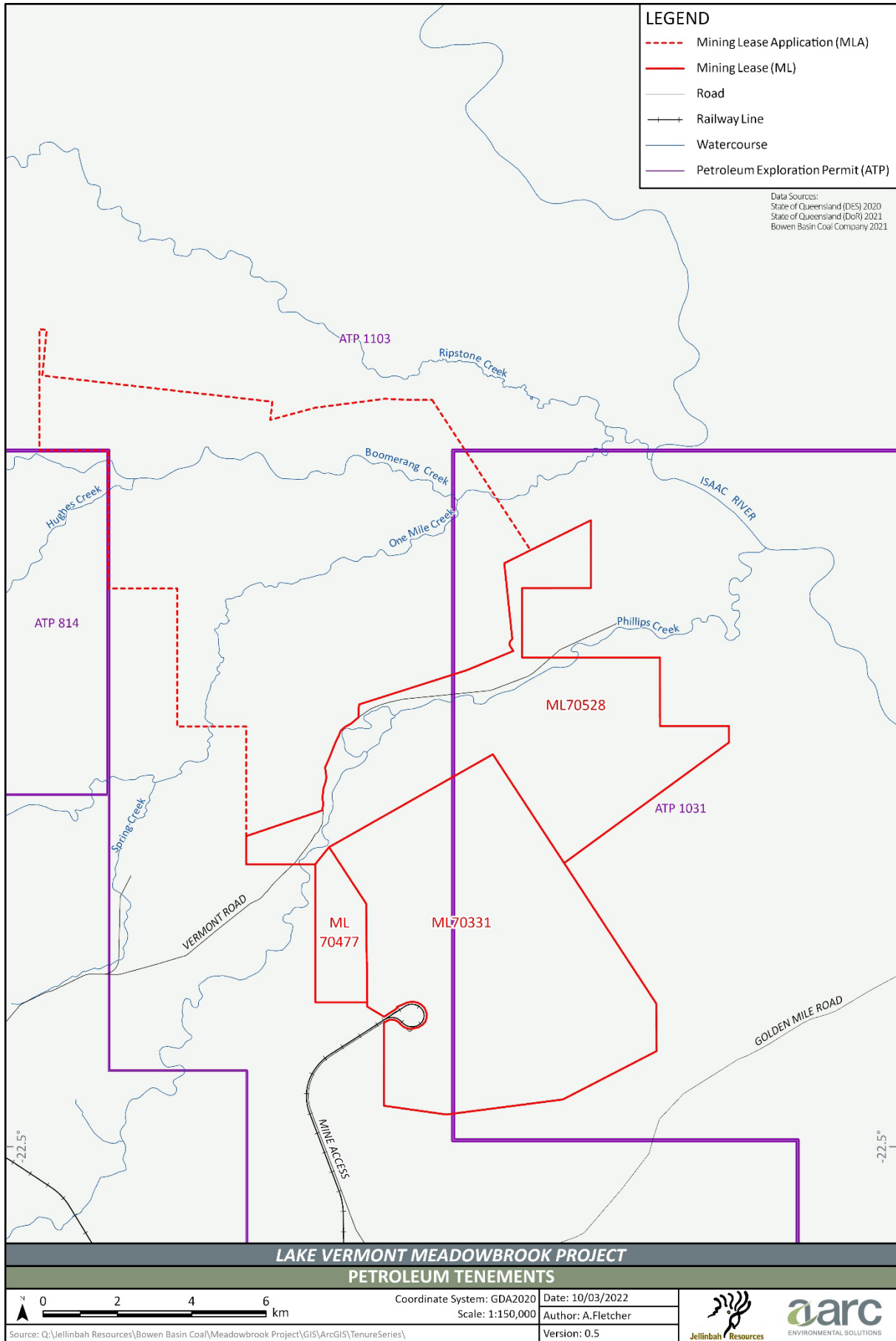

Figure 3.11: Petroleum tenements



3.2.2 Existing infrastructure

3.2.2.1 Road infrastructure

As shown in Figure 3.12, the main road transport routes in the vicinity of the Project are:

- Peak Downs Highway;
- Peak Downs Mine Road;
- Saraji Road;
- Queen Elizabeth Drive;
- Dysart Bypass Road;
- Golden Mile Road; and the
- Lake Vermont Access Road.

The Fitzroy Development Road provides an alternative route to access the Project from the north, although it is expected to be used by a minority of Project traffic.

Peak Downs Highway is a state-controlled road between Mackay and Clermont. It services a number of coal mines within the region and connects with the Peak Downs Mine Road. The Peak Downs Highway is a two-lane, sealed highway with a posted speed limit of 100 km/h.

Peak Downs Mine Road is a council-controlled road (IRC) that provides access between the Peak Downs Highway and Saraji Road. The Peak Downs Mine Road is a two-lane, sealed road with a posted speed limit of 80 km/h.

Saraji Road is a council-controlled road that provides access between Dysart and the Peak Downs Highway. It is a two-lane, sealed, rural, arterial road with a posted speed limit of 100 km/h.

Queen Elizabeth Drive is a council-controlled, two-lane, sealed road that provides light vehicle access between Saraji Road and Golden Mile Road. The road has a posted speed limit of 60 km/h.

The Dysart Bypass Road is a council-controlled, two-lane, sealed road that provides heavy vehicle access between Saraji Road and Golden Mile Road and bypasses Queen Elizabeth Drive. The road has a posted speed limit of 60 km/h.

Golden Mile Road is a council-controlled road that provides access between the Project and Dysart, including the Lake Vermont Accommodation Village. It is a two-lane, sealed, rural arterial road with a 60 km/h to 100 km/h posted speed limit.

Lake Vermont Mine Access Road is a private sealed road between Golden Mile Road and the Lake Vermont Mine. It has two lanes and a posted speed limit of 80 km/h.

Fitzroy Developmental Road is a state-controlled Road that provides access between Golden Mile Road (and Carfax Road) and the Peak Downs Highway. It is a two-lane, sealed highway with a posted speed limit of 100 km/h.

Carfax Road is a council-controlled road that provides access between Golden Mile Road and the Fitzroy Development Road. It is a two-lane, sealed, rural arterial road with a posted speed limit of 100 km/h.

A number of private unsealed roads and tracks are also within the Project area. Quarry materials will be sourced from a local provider *via* a private haul road to the site, which will limit heavy vehicle movements on the Golden Mile Road during all Project phases.

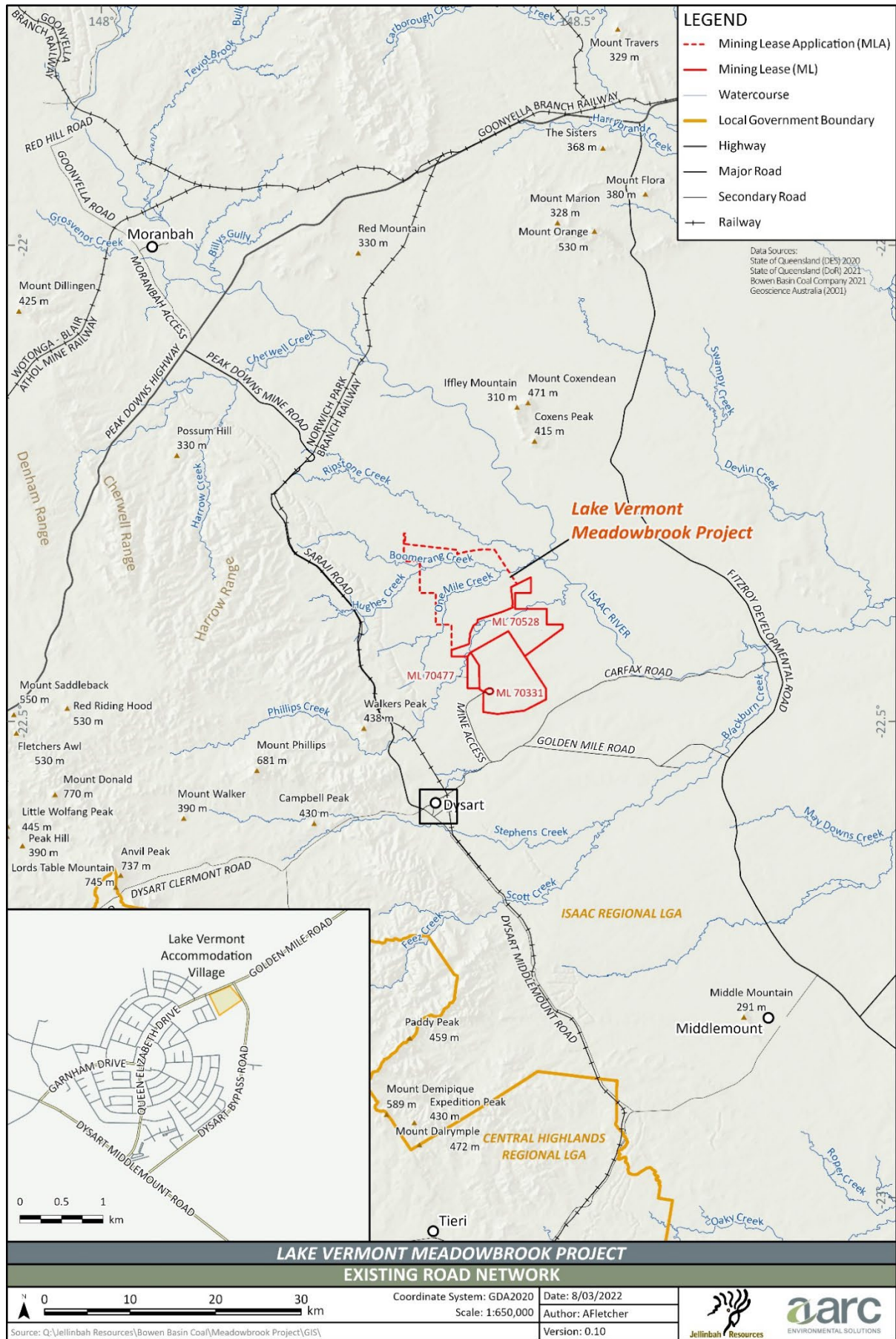

Figure 3.12: Existing road network



Vermont Road is another rural road that intersects with Saraji Road and provides access to a small number of rural residences or exploration activities for the Saraji Mine (Figure 3.9). As indicated in section 3.2.1, the Vermont Road easement (Lot H on SP260662) traverses Lake Vermont Mine's mining lease (ML 70528) in an east–west direction; however, there is no constructed road within the easement. Vermont Road would not be used to access the Project.

3.2.2.2 Rail and port infrastructure

The Goonyella Railway System services the coal mining area of the Bowen Basin by transporting coal to the Hay Point and Dalrymple Bay Coal Terminals in Mackay and, *via* the Newlands Railway System, to the Abbot Point Coal Terminal in Bowen (Figure 3.13). To the south, the Goonyella Railway System connects with the Blackwater Railway System delivering coal from the Bowen Basin to the Port of Gladstone (Figure 3.13) where the Wiggins Island, RG Tanna and Barney Point Coal Terminals are located.

The Lake Vermont Mine has an existing spur line and rail loop branching off the Norwich Park Branch Railway (Goonyella Railway System). Product coal is railed to the RG Tanna Coal Terminal in Gladstone or Abbot Point Coal Terminal in Bowen for export. The Lake Vermont Mine also has the capability of railing coal to the Dalrymple Bay Coal Terminal in Mackay when opportunities permit.

3.2.2.3 Air infrastructure

Mackay and Emerald Airports are the nearest major regional airports servicing the region (Figure 3.13). The Mackay Airport (approximately 230 km north-east of the Project by road) is part of the North Queensland Airports Group, which owns and operates the Mackay Airport as well as the Cairns Airport and Mackay Airport Hotel. Emerald Airport (approximately 165 km south of the Project by road) is a commercial business unit of the Central Highlands Regional Council, which is responsible for the management and operations of the airport.

Other regional airports in the vicinity of the Project include the Moranbah Airport (approximately 77 km north by road), which is operated by BMA which provides charter flights and commercial flights with major operators (e.g. Qantas and Virgin).

3.2.2.4 Energy infrastructure

The Dysart substation is a 132/66/22 kV facility to the north-east of Dysart and is jointly owned by Powerlink and Ergon Energy. The substation provides electricity to the Dysart area and rural properties at 22 kV, as well as a number of coal mines at 66 kV. The Lake Vermont Mine is connected to the substation *via* a 66 kV electricity transmission line (ETL). The Ergon Energy Vermont substation is adjacent to Lake Vermont Mine's MIA (adjacent to the CHPP).

Additional energy infrastructure is proposed to be developed to provide electricity to the Project, as described in section 3.3.6.

3.2.2.5 Water infrastructure

The Eungella Dam is approximately 80 km west of Mackay and 35 km west of Eungella. A pipeline from the dam supplies water to mines in the Bowen Basin and the township of Moranbah. The Eungella Water Pipeline was commissioned by Sunwater in 1997, with later extensions constructed to Coppabella and the Lake Vermont Mine (Eungella Water Pipeline Southern Extension). The Eungella Water Pipeline Southern Extension is shown in Figure 3.2.

Bowen Basin Coal holds a water supply agreement with Sunwater's Eungella Water Pipeline Pty Ltd for the supply of up to 1,500 ML of water per annum to the Lake Vermont Mine. Bowen Basin Coal also has an on-supply contract with Peabody to transfer Peabody's 1,000 ML per year water allocation to the Lake Vermont Mine. The Lake Vermont Mine has a network of raw water, clean water and mine water dams on-site to manage water and to minimise the demand of raw water from the Eungella Water Pipeline Southern Extension.

Additional water management and supply infrastructure is proposed to be developed to support the Project, as described in Water supply and management infrastructure in section 3.3.7.



Figure 3.13: Rail, sea and air transport facilities



3.2.3 Topography, landforms and catchments

Ground elevations to the west of the Project are marginally higher in elevation (approximately 10 mAHD), with the Project generally draining west to east towards the Isaac River (Figure 3.14). The Isaac River passes to the east of the MLA, flowing in a south-easterly direction. The land surface between Phillips Creek and Boomerang Creek is a broad, flat floodplain that slopes gently eastwards from approximately 180 m AHD west of the Project site to around 170 m AHD east of the site (Figure 3.14).

The Project site is within the Isaac Connors sub-catchment, an area encompassing 22,325 km² within the greater Fitzroy Basin catchment.

The primary watercourses that traverse the Project site are Boomerang Creek (a fifth order stream), Phillips Creek (a fourth order stream) and One Mile Creek (a third order stream). Ripstone Creek (also a third order stream) is further to the north of the Project area. (Figure 3.14).

Boomerang Creek, One Mile Creek and Phillips Creek are all defined watercourses under the Queensland *Water Act 2000*. These waterways all drain into the Isaac River and east to the Coral Sea *via* the Mackenzie River and Fitzroy River.

It is noted that the Olive Downs Coking Coal Project has approval to divert Ripstone Creek near the northern boundary of the Project MLA. The Surface Water Assessment for the Olive Downs Coking Coal Project concluded that the Ripstone Creek diversion would not significantly change the hydraulic behaviour of this watercourse (Hatch 2018). Similarly, the Saraji Mine has an existing diversion/levee on Phillips Creek, with a further diversion of Phillips Creek having also been approved downstream as part of the Lake Vermont Mine operations (refer Figure 3.14). The Lake Vermont Mine diversion has not yet been constructed.

3.2.4 Geology and economic resources

3.2.4.1 Regional and local geology

The Project is located in the western limb of Queensland's Bowen Basin, a north-south trending retro-arc basin that extends more than 250 km north to south and up to 200 km west to east. The Project lies at the eastern end of the Collinsville Shelf that is characterised by a thin accumulation of sediments gently dipping easterly, with minor structural deformations. The eastern boundary of the Collinsville Shelf occurs at the Isaac Fault, a major thrust fault which has throws of 150 m to 400 m in the Project area.

Figure 3.15 shows a geological map of the Project area that has been prepared by removing the Cainozoic (Quaternary and Tertiary) cover sediments revealing the faulted relationship between the underlying Permian and Triassic rocks of the Project area. Figure 3.15 is based on the Bowen Basin solid geology of Sliwa *et al.* (2008), except it has been modified by Project geologists (Minserve) based on geological drilling and interpretation within the Project area.

Figure 3.15 also shows a number of local scale faults that have been mapped from seismic and drilling data collected for the Project. Both normal and reverse faults have been identified by 3D seismic surveys, consistent with neighbouring mining areas in the Rangal Coal Measures. A higher number of reverse style structures occur closer to the Isaac Fault. These faults can be significant in terms of the deposit geology where the throws of the faults are in the order of 10 m to 15 m (having the potential to completely offset the coal seams). As the coal seams tend to be the conduits for groundwater flow in the Permian sediments, these faults also have the potential to disrupt groundwater flow. Geological faulting is discussed in further detail in Appendix A, Subsidence Assessment, Section 2.2.5.6.

The regional stratigraphy of the Bowen Basin contains a number of lateral equivalents that are referred to by different names in the northern and southern areas of the Bowen Basin. The stratigraphic relationship is summarised below in Table 3.4. The local stratigraphy of the Project area is discussed in detail in Chapter 7, Groundwater.

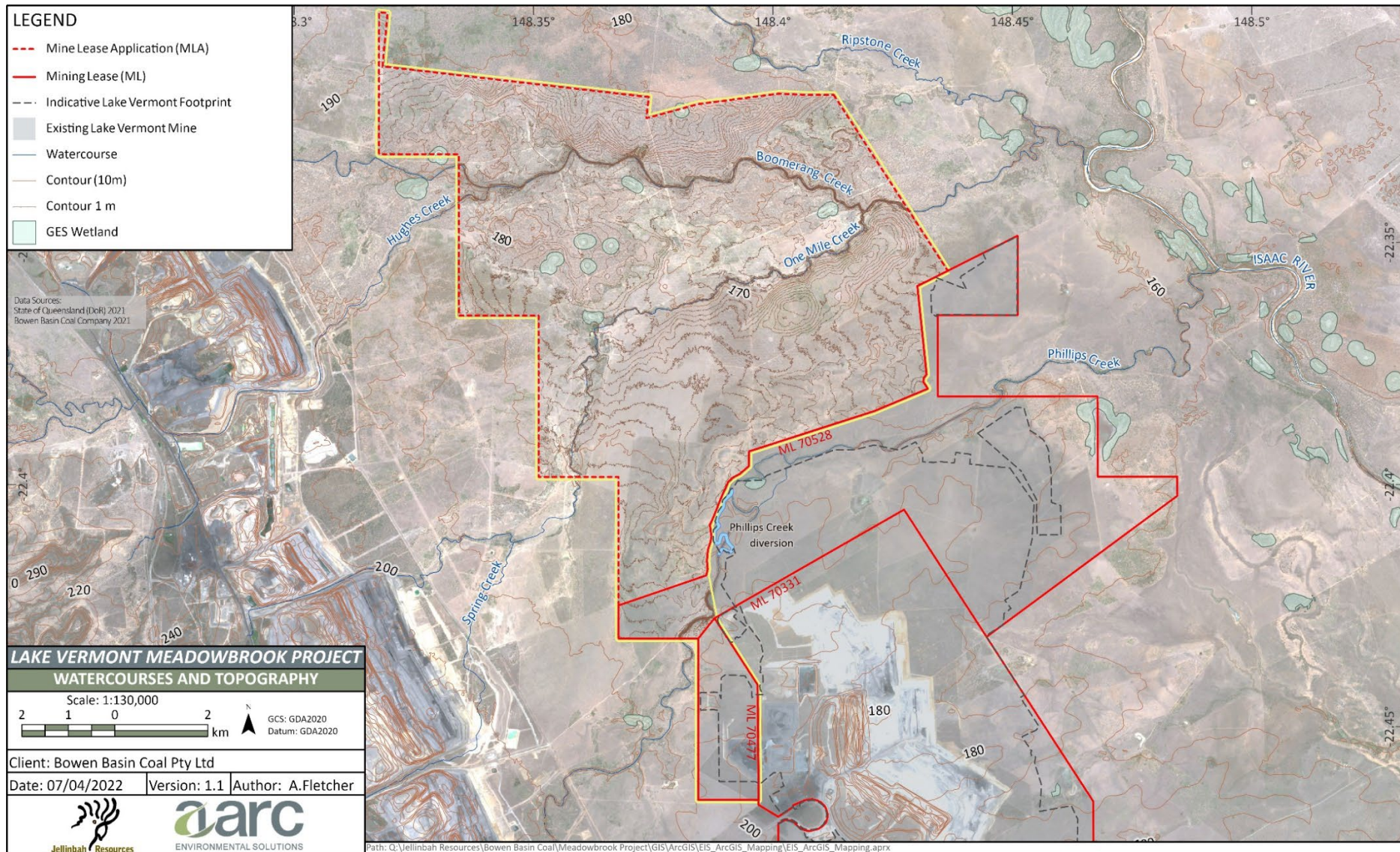

Figure 3.14: Project watercourses and topography

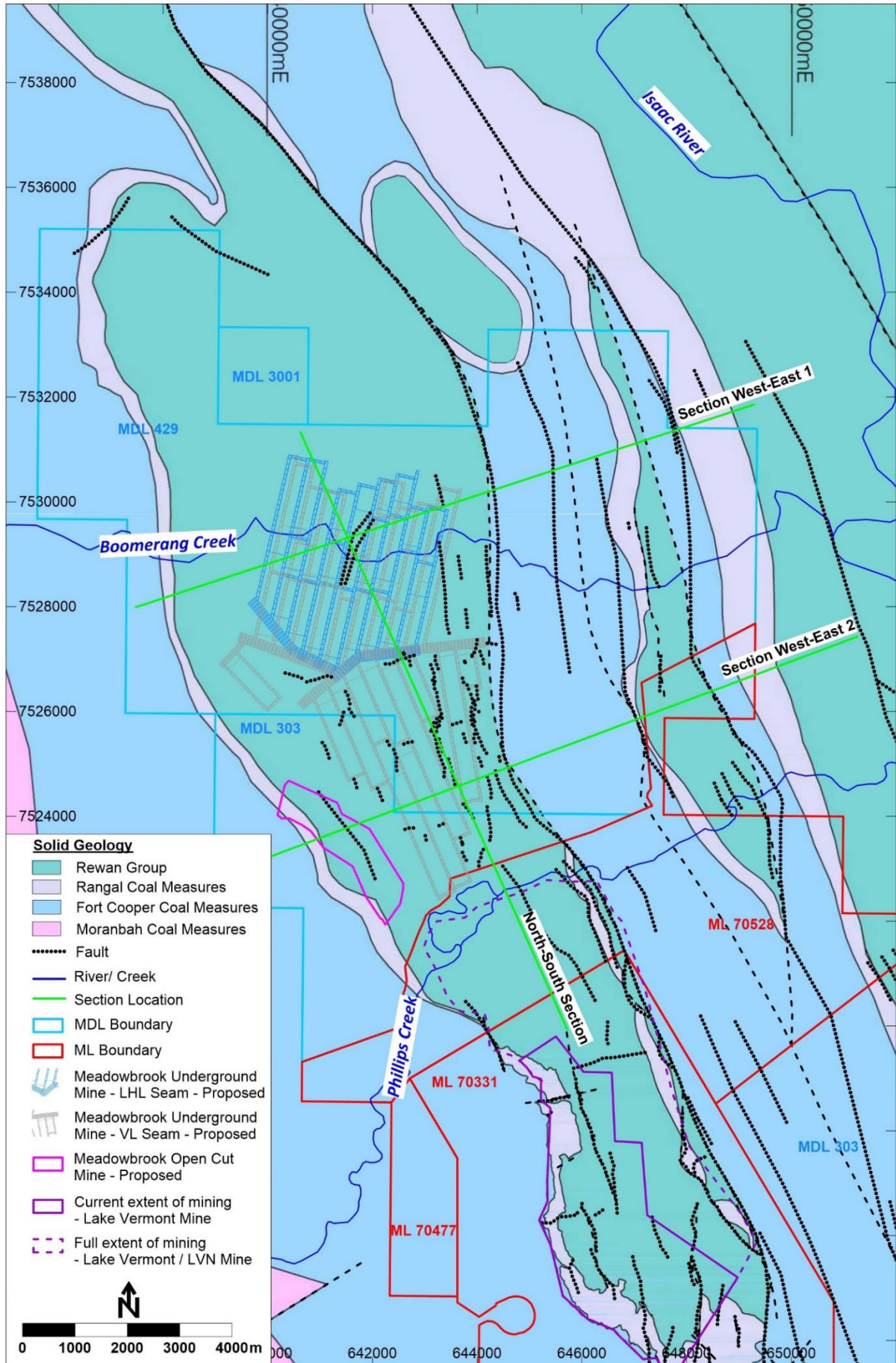

Figure 3.15: Geology of the Project site



Table 3.4: Bowen Basin regional stratigraphy

Age	Group	Formation	
		Southern Bowen Basin	Northern Bowen Basin
Quaternary		Alluvium	Alluvium
Tertiary		Alluvium	Alluvium
		Main Range Basalt	Main Range Basalt
		Duaringa Formation	Duaringa Formation
Triassic	Rewan Group	Arcadia Formation	Arcadia Formation
		Sagittarius Sandstone	Sagittarius Sandstone
Late Permian	Blackwater Group	Rangal Coal Measures	Rangal Coal Measures
		Burngrove Formation	Fort Cooper Coal Measures
		Fairhill Formation	
		MacMillan Formation	Moranbah Coal Measures
		German Creek Formation	
Middle Permian	Back Creek Group	Ingelara Formation	Blenheim Formation

Within the Project area, the Permian and Triassic-age sediments of the Bowen Basin are overlain with a veneer of unconsolidated to poorly consolidated Tertiary and Quaternary sediments. The surface geology for the Project area is shown in Figure 3.16. The detail shown in Figure 3.16 is based on 1:100,000 scale digital geology of the region and Project area and indicates areas where Cainozoic sediments and basalt (to the west of the Project area) overlay the Permo–Triassic Bowen Basin sediments.

Figure 3.15 and Figure 3.16 also identify the locations of geological cross-sections that have been undertaken for the Project (with two west–east sections oriented across strike and one north–south section that has been oriented through the central area of the proposed underground mining). The west–east sections are shown in Figure 3.17, with the north–south section shown in Figure 3.18. These sections have been prepared to assist the understanding of stratigraphic and structural relationships of the Project geology.

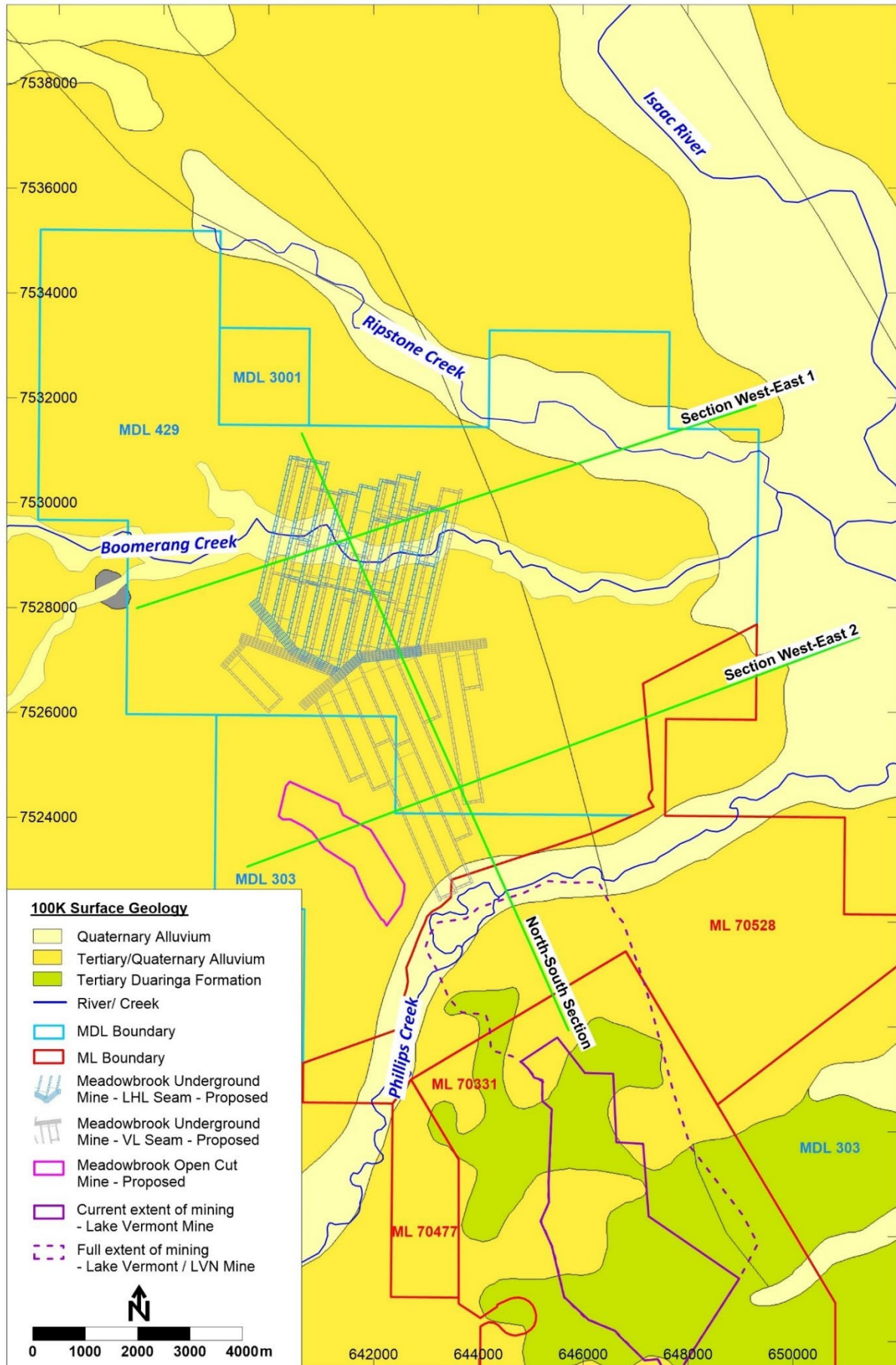

Figure 3.16: Surface geology of the Project site

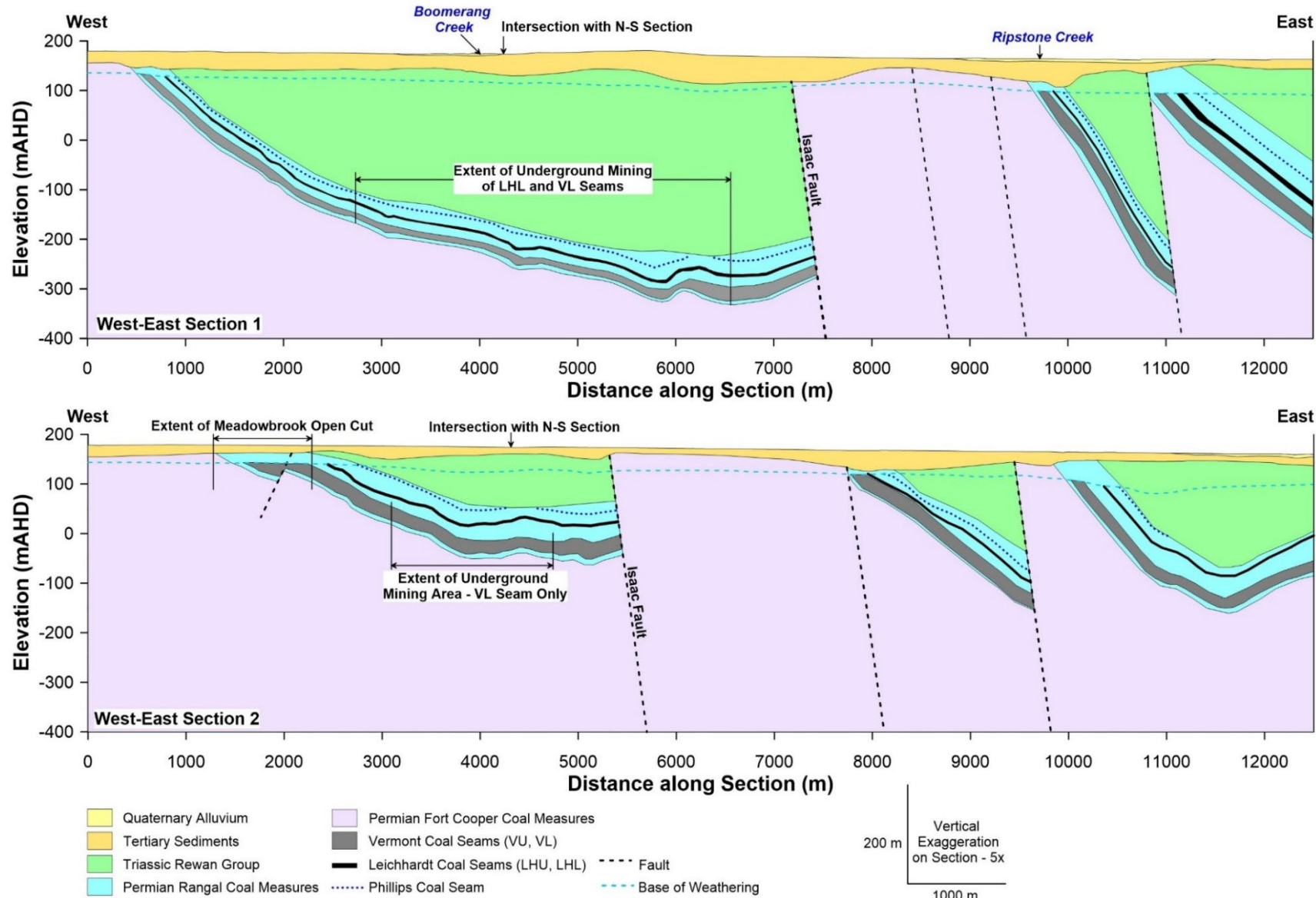

Figure 3.17: West-east cross-sections of Project geology

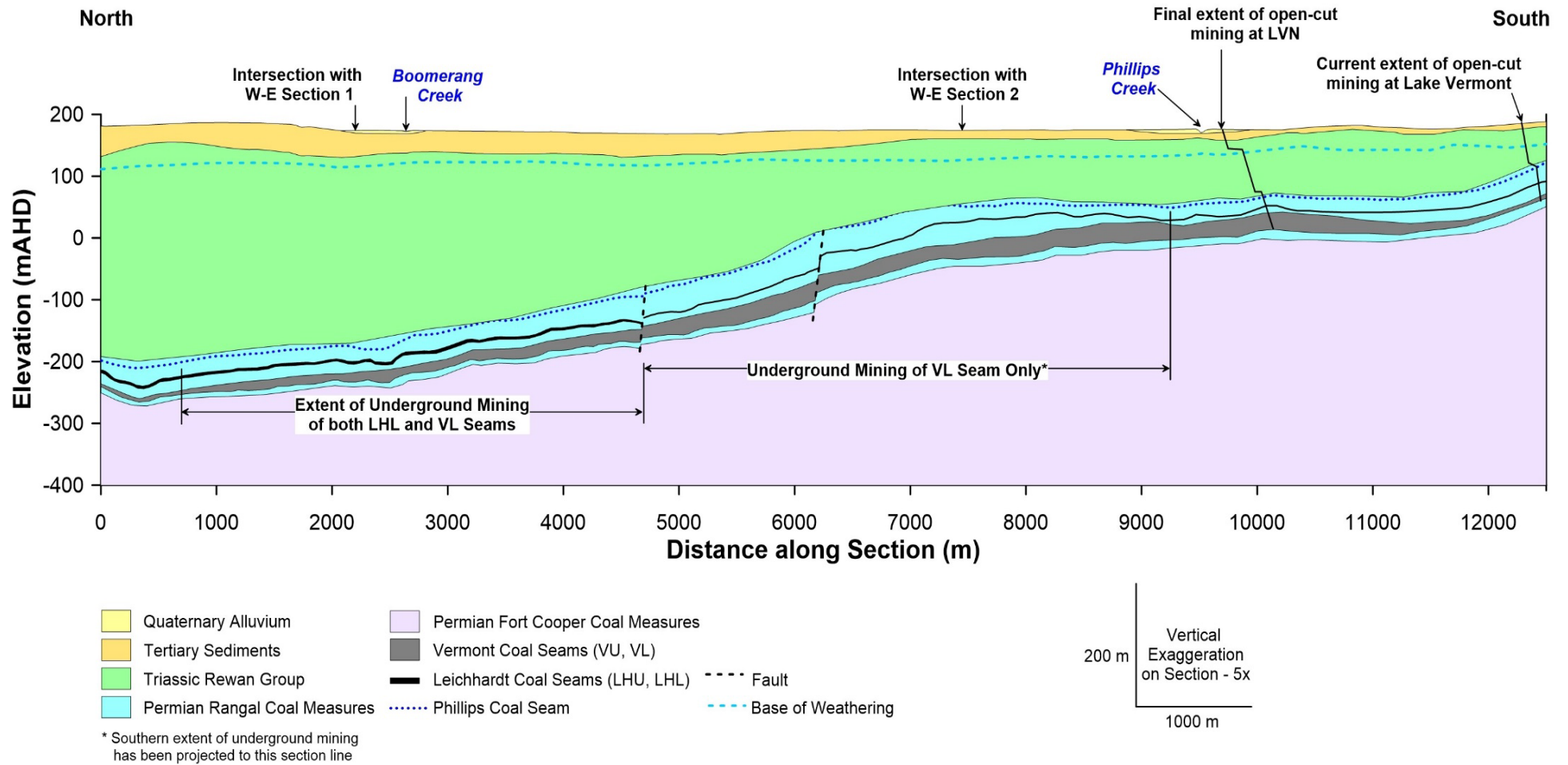

Figure 3.18: North-south cross-section of Project geology



3.2.4.2 Exploration history and coal resource

The Lake Vermont Meadowbrook Project mining area is covered by closely spaced drill holes undertaken as part of successive exploration drilling programs. Exploration drilling has recorded the geological sequence of the overburden and coal seams, as well as the sediments immediately below the target seams. Geophysical logs are also available for the majority of boreholes and provide additional data on rock and coal seam properties. Both 2D and 3D seismic surveys have been carried out across the Project area, with the most recent 3D seismic survey conducted in 2020. The exploration program provides a high-level of confidence in the geological variables within the Project area.

Economic coal seams at the Project occur within the Rangal Coal Measures, a sub-group of the Late Permian aged Blackwater Group. These coal seams are persistent, thick coal horizons with the following descending stratigraphic sequence:

- the Leichhardt Seam and Leichhardt Lower Seam; and
- the Vermont Seam and Vermont Lower Seam.

The Vermont Lower Seam extends across the Project underground mining area, while the Leichhardt Lower Seam is limited to the northern half of the underground mining area. Open-cut mining of the satellite pit will target the Vermont Lower Seam, Vermont Seam and Leichhardt Seam.

The underground mining area is limited to the west due to increasing seam gradients as the target seams dip more steeply approaching the western sub-crop, reaching gradients of approximately 1:6. A limiting seam gradient of approximately 1:8 has been adopted to limit the western boundary of the underground footprint. The dip progressively flattens across the underground mining area towards the east to typical gradients of 1:20. This flattening of the seam with depth away from the sub-crop is characteristic of other deposits in the Rangal Coal Measures.

In the underground mining area, the thickness of the Vermont Lower Seam is typically between 3.0 m and 4.8 m, and the thickness of the Leichhardt Lower Seam is typically between 3.0 m and 5.0 m. The seams to be mined by open-cut methods typically range in thickness from 1.5 m to 4.0 m. The Project coal seams provide high-quality hard coking coal, PCI coal and an industrial coal product.

3.2.5 Soils and land use

3.2.5.1 Soils

Eight soil management units (SMUs) have been identified across the Project area. The spatial distribution of these soils is shown in Figure 3.19, with further details on SMUs provided in Chapter 5, Land Resources.

Soil erodibility and the dispersion potential of soils have been assessed for SMUs using key soil characteristics. Soil erodibility, the susceptibility of soil to become detached and transported by erosive agents, such as wind and water, is dependent on the mechanical, chemical and physical characteristics of the soil and is independent of other factors influencing soil erosion, such as topography and land use (DSITI 2015). Erosion hazard and subsoil erodibility of SMUs from the 2020 field survey has been based on the 'Regional Land Suitability Frameworks for Queensland' (DSITIA and DNRM 2013), Characteristics include:

- an exchangeable sodium percentage that indicates soil sodicity when clays dominated by calcium ions are less likely to disperse compared to clays dominated by sodium ions;
- a Ca:Mg ratio when higher Mg increases the dispersive nature of sodic clays; and
- an Emerson aggregate test that determines the susceptibility of soils to surface sealing under rainfall or irrigation; that is, the dispersivity of the soil and predisposition of the soil to becoming erosive under natural conditions.

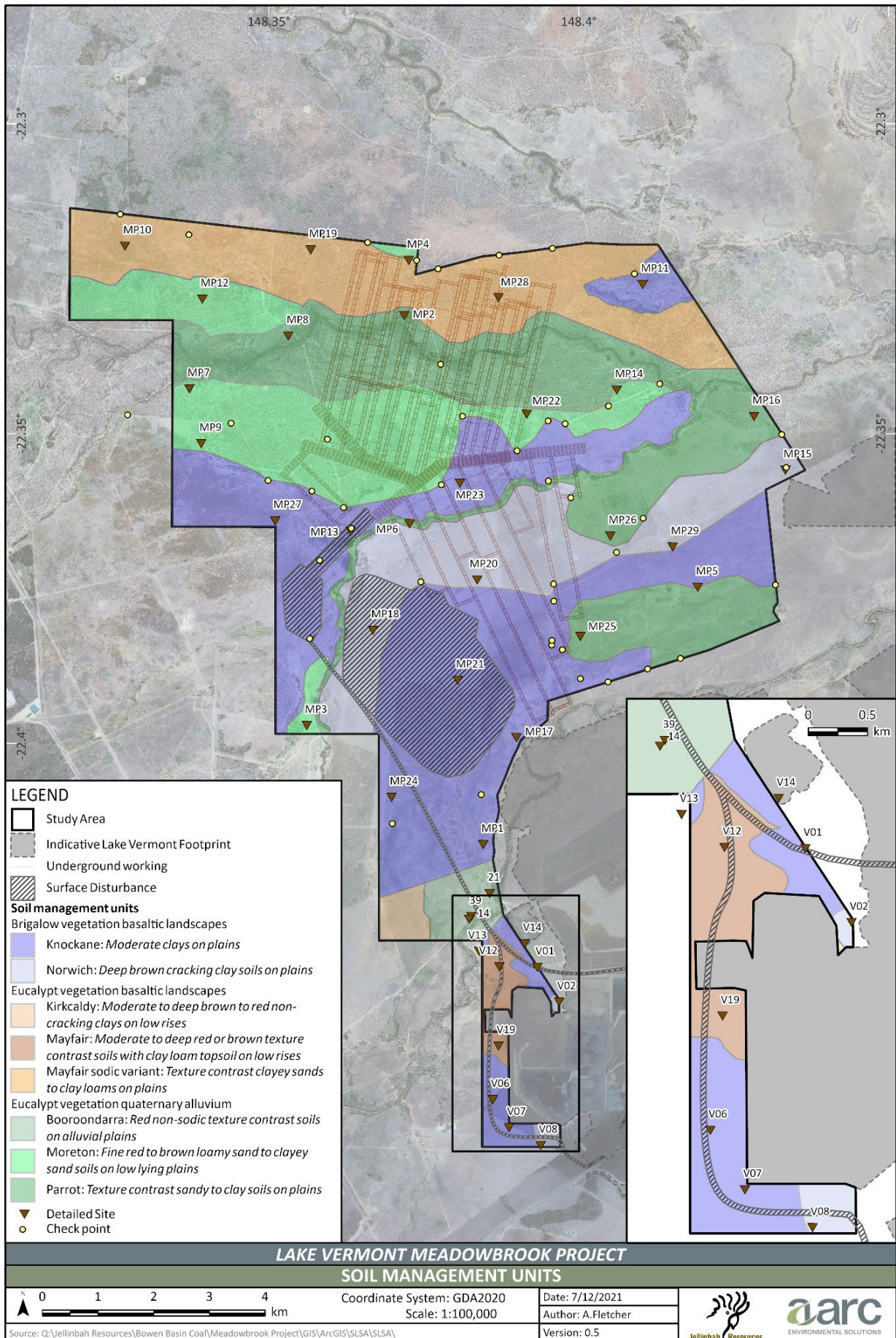

Figure 3.19: Soil management units for the Project



Erosion hazard of Booroondarra, Mayfair and Moreton SMUs has been determined from the reported key soil characteristics from the previous Soil and Land Suitability Assessment (SLSA) findings (NQSA 2012 and Australasian Resource Consultants 2013).

The results of the SLSA are described in further detail in Chapter 5, Land Resources.

3.2.5.2 Land use

The current land use of the Project area is rural with low-intensity cattle grazing and resource exploration activities. The Project area adjoins several existing coal mining operations:

- Lake Vermont Mine immediately to the south;
- Saraji Mine and the Saraji East Project to the west; and
- The Olive Downs Coking Coal Project to the north.

No protected areas (nature refuges, national parks), state-controlled roads or rails or land within the planned expansion are reserved for stock routes, easements or quarries.

The 'Isaac Regional Planning Scheme' mapping identifies a portion of Class A cropping agricultural land within the Project area in the south-east of ML 70477 (approximately 6 ha). The remainder of the Project area is mapped as Class C pasture land. The 'Queensland Agricultural Land Audit' mapping identifies the Project as partially located on land mapped as the Golden Mile Important Agricultural Area (IAA) (Figure 3.20).

The Golden Mile IAA is identified as a critical mass of land that satisfies the requirements for successful and sustainable agricultural activities (DAF 2018). The Golden Mile IAA covers 969,803 ha extending from Valkyrie, 20 km north of the Project study area, to Mackenzie River, approximately 120 km south. It is the only IAA within the Mackay, Isaac and Whitsunday Regions. Grazing is the predominant land use of the Golden Mile IAA, and it comprises approximately 85% of the total area of the region. Other land uses (including mining) occupy approximately 10% of the region, with intensive agriculture occupying approximately 5%.

The southern portion of the Project area intersects with the north-western portion of the Golden Mile IAA and it overlaps approximately 5,672 ha of the Project area. Disturbance associated with the Project area overlaps approximately 894 ha of the Golden Mile IAA (approximately 0.1%).

3.2.6 Protected areas

Protected areas in Queensland include national parks, nature refuges and other areas established under the *NC Act 1992*. No protected areas occur within the Project area; however, the Peak Range National Park is approximately 50 km to the south-west (Figure 3.1). The Peak Range National Park is adjoined to the north by the Lords Table Mountain Nature Refuge, with the Norwich Park Nature Refuge and Coolibah Nature Refuge to the south of the Project (Figure 3.1). There are no World Heritage areas within the Project area or surrounds.

Wetland mapping established under the 'Queensland Environmental Protection (Water and Wetland Biodiversity) Policy 2019' indicates that several High Ecological Significance (HES) wetlands and associated Wetland Protection Areas (WPAs) exist to the east of the Project site (Figure 3.21). The closest of these HES wetlands are near the confluence of Boomerang Creek and Ripstone Creek, as well as approximately 1 km south of Phillips Creek approaching the confluence with the Isaac River (Figure 3.21). HES wetlands and WPAs are identified as matters of state environmental significance (MSES) under Queensland's *EO Act 2014*. Impacts to HES wetlands and WPAs are considered in Chapter 11, Aquatic Ecology.

A number of General Ecological Significance (GES) wetlands, defined as vegetation management wetlands under the *Vegetation Management Act 1999* (VM Act), are located within the Project area and surrounds (Figure 3.21). No wetlands of international importance ('Ramsar' wetlands) are within or are proximate to the Project.

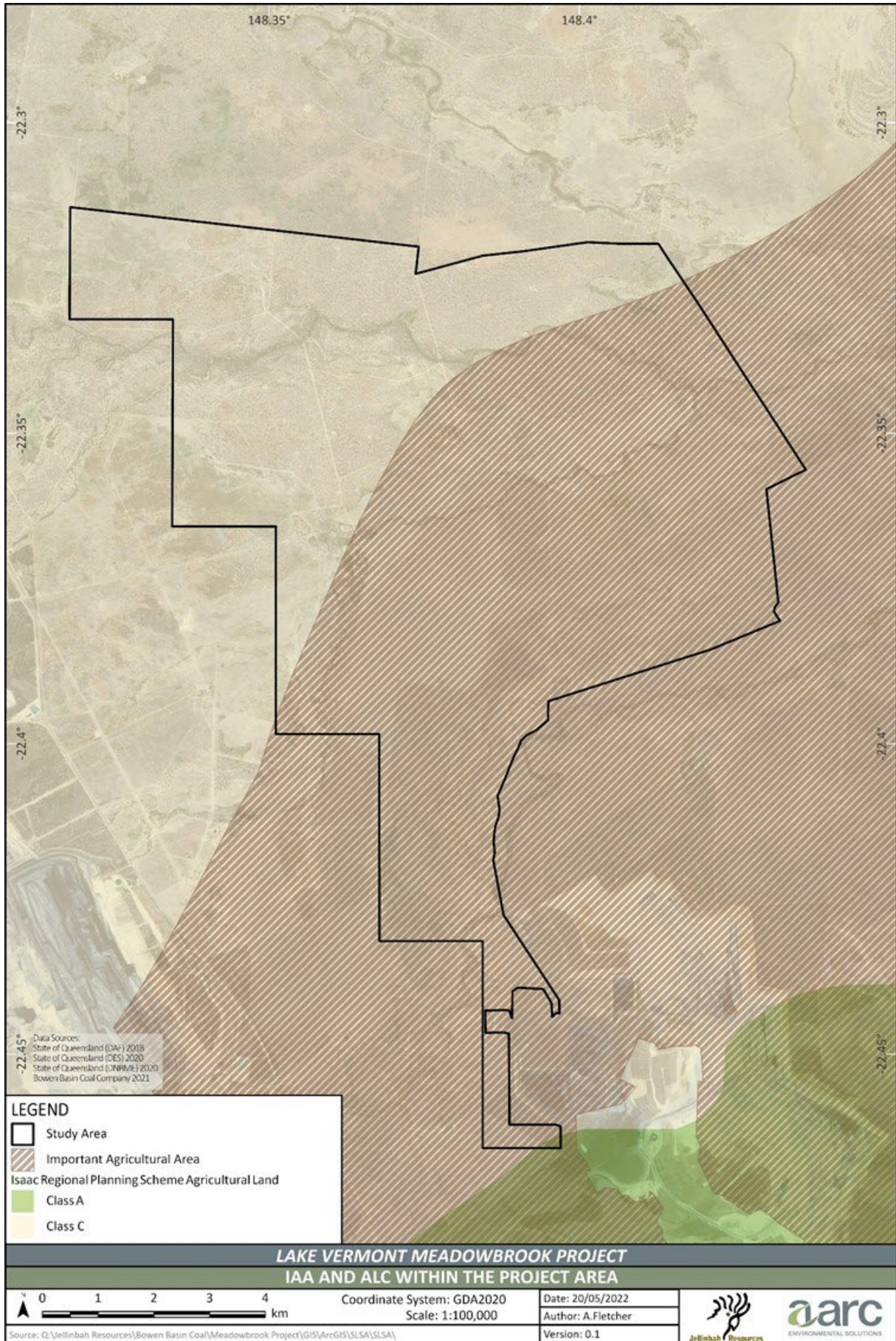

Figure 3.20: IAAs and agricultural and classes within the Project area

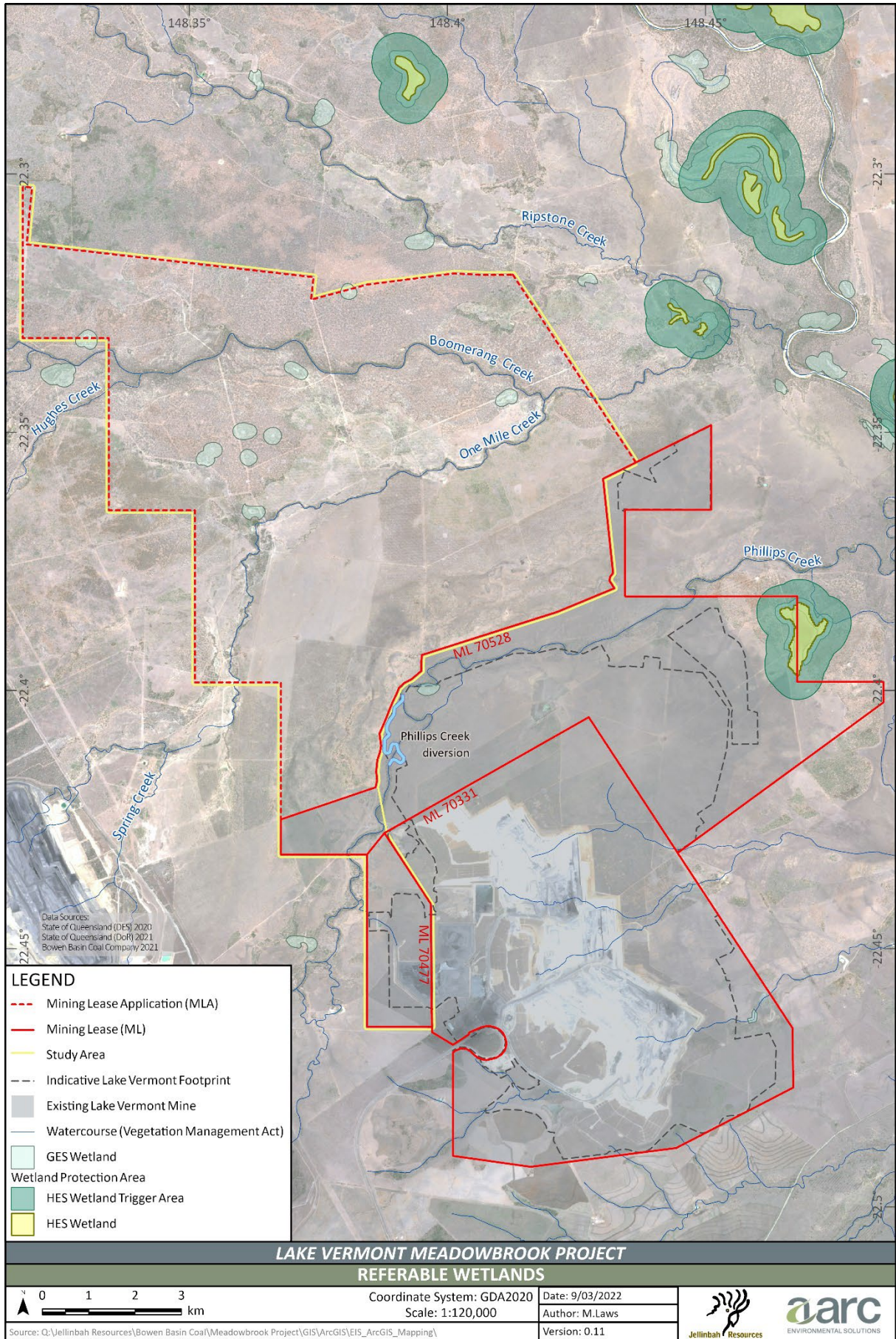

Figure 3.21: Referable wetlands



As described in section 3.2.3 and shown in Figure 3.21, a number of waterways (defined as watercourses under the Water Act) are within or in the vicinity of the Project area. These include:

- Isaac River (to the east);
- Ripstone Creek (to the north);
- Hughes Creek;
- Boomerang Creek;
- One Mile Creek; and
- Phillips Creek.

These waterways are also defined as watercourses under the VM Act (refer Figure 3.21). Vegetation along a defined VM Act watercourse is considered an MSES for the purposes of the EO Act. Impacts to watercourses are considered in:

- Chapter 8, Surface Water;
- Chapter 10, Terrestrial Ecology;
- Chapter 11, Aquatic Ecology; and
- Chapter 21, MNES.

Waterways that provide for fish passage are also defined as MSES. The Department of Agriculture and Fisheries (DAF) 'Queensland Waterways for Waterway Barrier Works' mapping assigns the risk of adverse impact from instream barriers on fish movement to a waterway. The DAF has mapped Boomerang Creek, Hughes Creek, Phillips Creek and Isaac River as being a 'major risk' of adversely impacting fish movement due to waterway barrier works, while One Mile Creek and Ripstone Creek are mapped as being a 'high risk'. Waterway crossings of Phillips Creek and One Mile Creek are proposed to be constructed for the Project. Assessment of the potential impacts to fish movement is provided in Chapter 11, Aquatic Ecology.

3.3 Construction

The Project, an extension to the existing Lake Vermont Mine, has been designed to integrate with the existing Lake Vermont Mine infrastructure to maximise mine efficiency and minimise environmental impacts.

Key Project construction activities include the development of:

- an infrastructure corridor to provide for site access, coal haulage, power supply, water supply and telecommunications;
- an MIA;
- underground mine access portals, drifts and ventilation shafts and fans;
- an ROM coal conveying and handling system;
- infrastructure for electricity supply;
- infrastructure for water supply; and
- mine water management infrastructure.

A description of the key components of the construction/development activities is provided in section 3.3.1 to section 3.3.9.



3.3.1 Infrastructure corridor

An infrastructure corridor will be constructed to connect the Project MIA to the existing infrastructure at the Lake Vermont Mine. The infrastructure corridor will enable the delivery of electricity, water and telecommunications to the Project, provide personnel and materials access and facilitate the delivery of ROM coal to the ROM pad at the Lake Vermont Mine.

The infrastructure corridor will include the following constructions:

- a haulage road for personnel, materials and coal haulage;
- watercourse crossings at Phillips Creek and One Mile Creek;
- an overhead 66 kV ETL;
- a raw water supply pipeline;
- two laydown areas to support construction activities; and
- telecommunications infrastructure.

Various route options for the infrastructure corridor have been assessed in consideration of safety, environmental and existing Lake Vermont Mine operational requirements and are described in detail in section 3.6.4. The proposed alignment of the infrastructure corridor has been selected to minimise disturbance to remnant vegetation, Phillips Creek, One Mile Creek and allow for the integration of ROM coal haulage with the existing operations. Consideration of the floodplain extent has also been afforded to the final alignment proposed, with the haul road construction anticipated to slightly modify the local flooding profile (as detailed in Chapter 9, Flooding and Regulated Structures). The proposed infrastructure corridor is shown in Figure 3.2. The infrastructure corridor is 45 m wide.

Construction of the access/coal haulage road and associated stream crossings within the infrastructure corridor is described in section 3.3.2.1.

Construction of the proposed 66 kV ETL and raw water supply pipeline is described in section 3.3.6 and section 3.3.7, respectively. Telecommunications infrastructure is described in section 3.5.3.

3.3.2 Access/coal haulage roads

The primary external access to the Project site will be *via* the existing Lake Vermont Mine Access Road. This access will be used for personnel, equipment and material deliveries.

Construction of the internal Project access/haulage road within the 45 m infrastructure corridor will be one of the first construction activities to commence to facilitate the subsequent construction of the underground drifts and portal.

The internal Project access/haulage road will be a sealed bitumen road to support haulage of ROM coal from the MIA to the existing Lake Vermont Mine ROM stockpiles (*via* road-train). This sealed haulage road will also facilitate access to the Project for personnel and materials (Figure 3.2). The coal haulage road design will incorporate a loop at the MIA ROM coal stockpile area and a loop at the existing Lake Vermont ROM pad to facilitate ROM coal loading and unloading.

Conceptual cross-sections of the Project access/haulage road (representing both fill and cut sections) are provided in Figure 3.22.

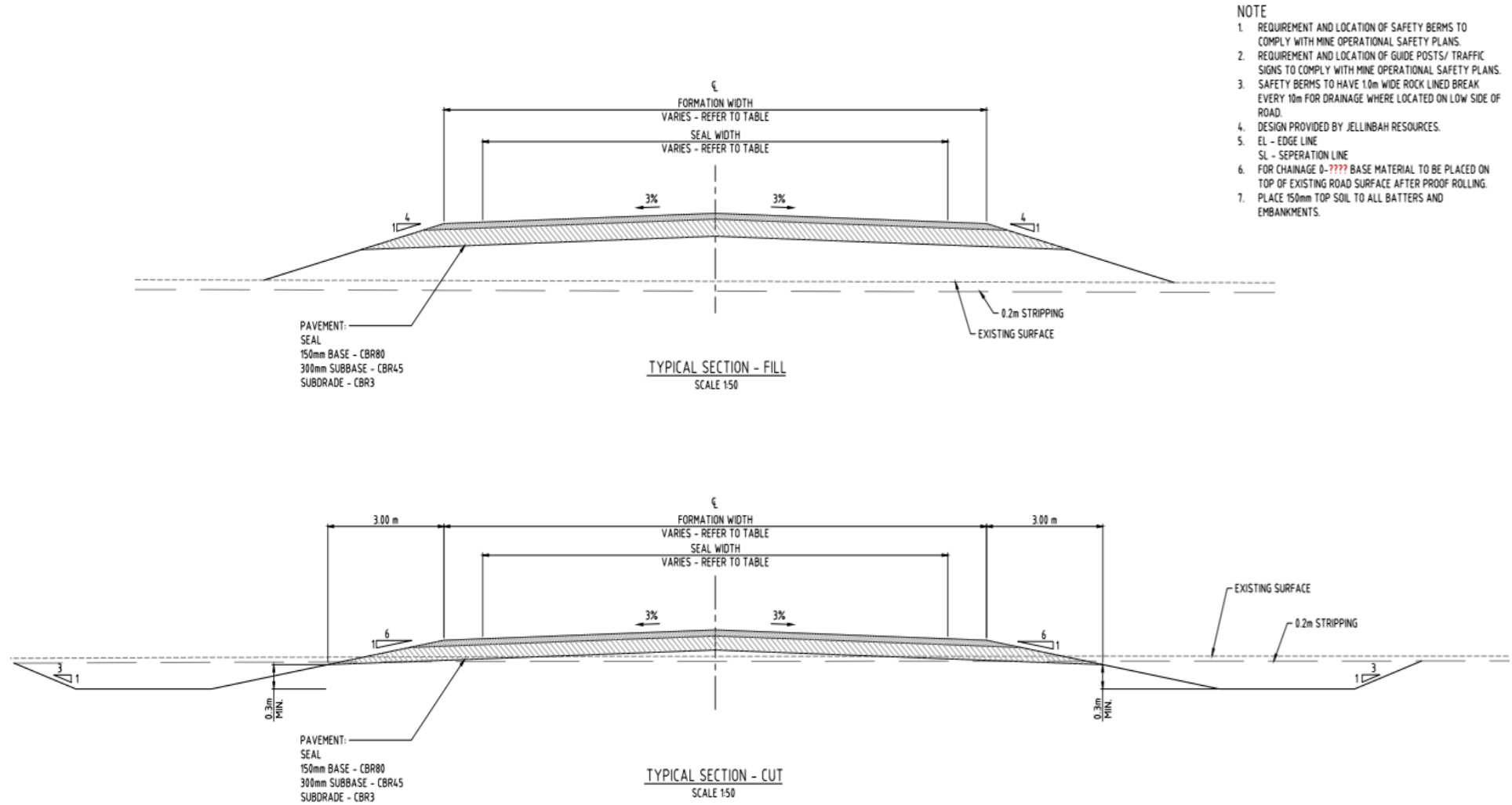

Figure 3.22: Conceptual cross-sections of the Project access/haulage road



3.3.2.1 Stream crossings

Construction of the access/coal haulage road will require stream crossings of Phillips Creek and One Mile Creek (Figure 3.2). The stream crossings will be constructed as causeways with appropriately-sized culverts to pass low flows. Conceptual design plans for the Phillips Creek and One Mile Creek crossings are shown in Figure 3.23.

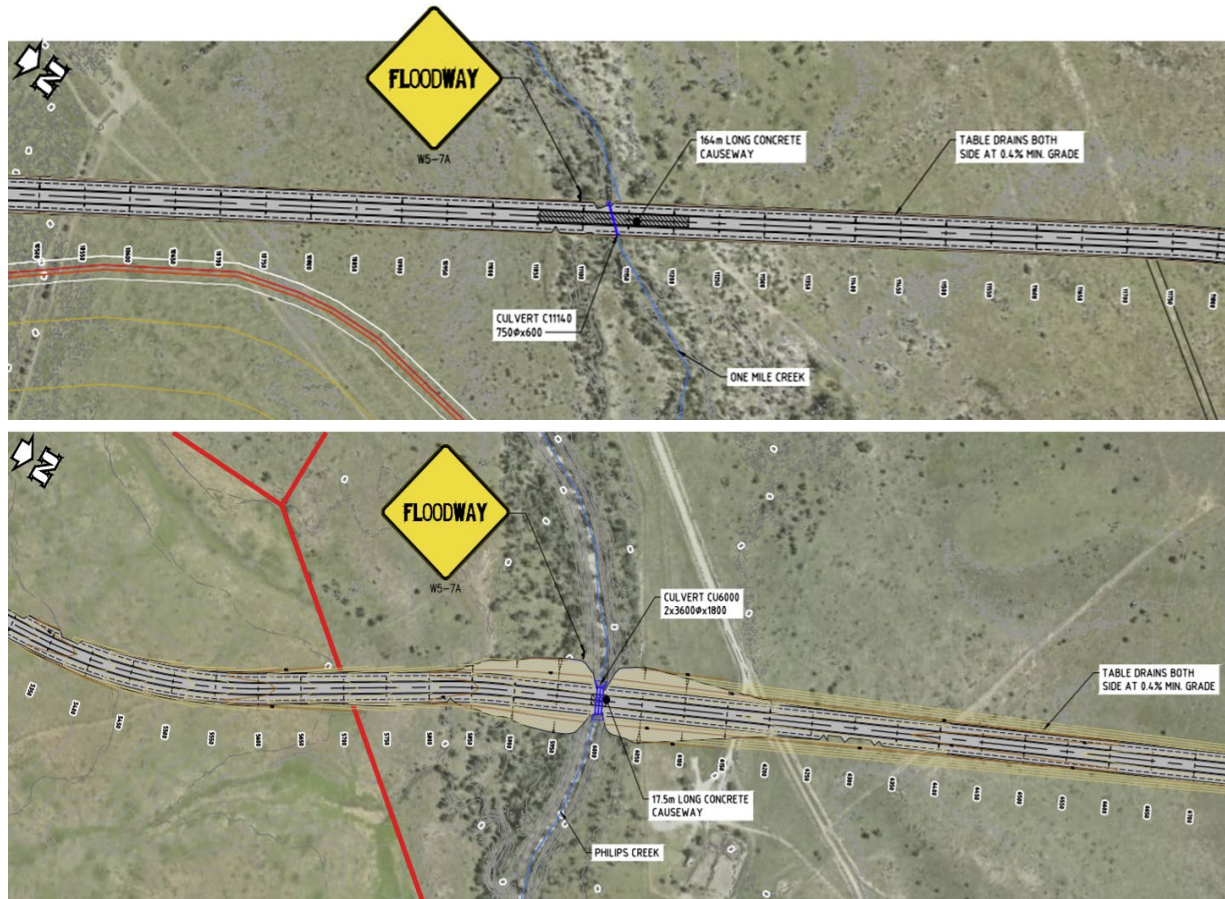

Figure 3.23: Conceptual designs of the Phillips Creek and One Mile Creek Crossings

Causeways are anticipated to be under water at some stage during most wet seasons, with the low flow creek crossing at 'Phillips Creek' having the least degree of flood immunity. This crossing has been modelled to have an 'average annual time of closure' of 19.3 hours. This crossing would be overtopped in a flow of approximately 26 m³/s, which is less than the 50% AEP flow (and likely significantly less than the 63% AEP flow). i.e. the Phillips Creek crossing would be expected to be overtopped at least once in most years (Appendix Z, Flooding Assessment Report, Section 3.3.4). This level of outage of the haul road is considered an acceptable impact to operations.

The causeway length for the One Mile Creek crossing will be approximately 164 m. It will be a concrete construction, with an underlying box culvert 750 mm wide x 600 mm high (Figure 3.23). The causeway length for the Phillips Creek crossing will be approximately 17.5 m. It will be a concrete construction, with two underlying box culverts 3600 mm wide x 1800 mm high (Figure 3.23). The sizing differences of these two causeways is representative of the different channel and bed structures of the two watercourses, as well as the respective flow regimes.

It is noted that the disturbance required to support construction of the Phillips Creek crossing will be approximately 100 m wide. This width is primarily required to facilitate excavation and grading of the channel bed to maintain existing flow velocities through this section of the stream (including the proposed culverts). Revegetation works will be undertaken as part of culvert construction activity, with causeways and culverts to remain post-mine closure (Chapter 6, Rehabilitation). Construction activities will be undertaken



during the dry season to minimise erosion and sediment mobilisation and ensure time to generate stability prior to wet season flows.

3.3.3 Mine infrastructure area (MIA)

The MIA will be constructed within the footprint as shown in Figure 3.2 and include the following key components:

- mine administration and operations buildings, including crib room, ablution, first aid and emergency management facilities;
- bathhouse facilities;
- warehouse and stores compound;
- equipment hardstand and laydown areas;
- equipment maintenance workshop and service bays;
- diesel storage and refuelling bay;
- underground transport mustering area;
- underground portal access to a personnel and transport drift, as well as a conveyor drift;
- ROM coal stockpile and associated infrastructure, including coal haulage loading area;
- raw water and mine water dams;
- flood protection levee;
- electricity distribution infrastructure;
- diesel backup generator;
- main surface fan installation;
- potable water treatment plant;
- sewage treatment plant (STP) and effluent irrigation areas; and
- other associated minor ancillary infrastructure.

The location for the MIA has been chosen in consideration of proximity and access to the underground mining area and the open-cut pit to ensure appropriate clearance for blasting operations and minimise disturbance to remnant vegetation and environmentally sensitive areas.

It is noted that the entire footprint of the MIA is assumed to be disturbed for the purposes of impact assessment. While it is unlikely that the entire MIA will be subject to ground disturbance, this conservative assessment approach enables some flexibility in final placement of infrastructure within the MIA footprint.

The proposed layout of the MIA is shown in Figure 3.24. As the MIA site is relatively flat, limited earthworks will be required. A levee is proposed to be constructed around the perimeter of the MIA (for flood protection). Levee design is based on protecting infrastructure within the MIA during flooding events (1:1,000 AEP), including protection of water ingress into the underground mine. MIA levee construction is discussed further in section 3.3.7.3.

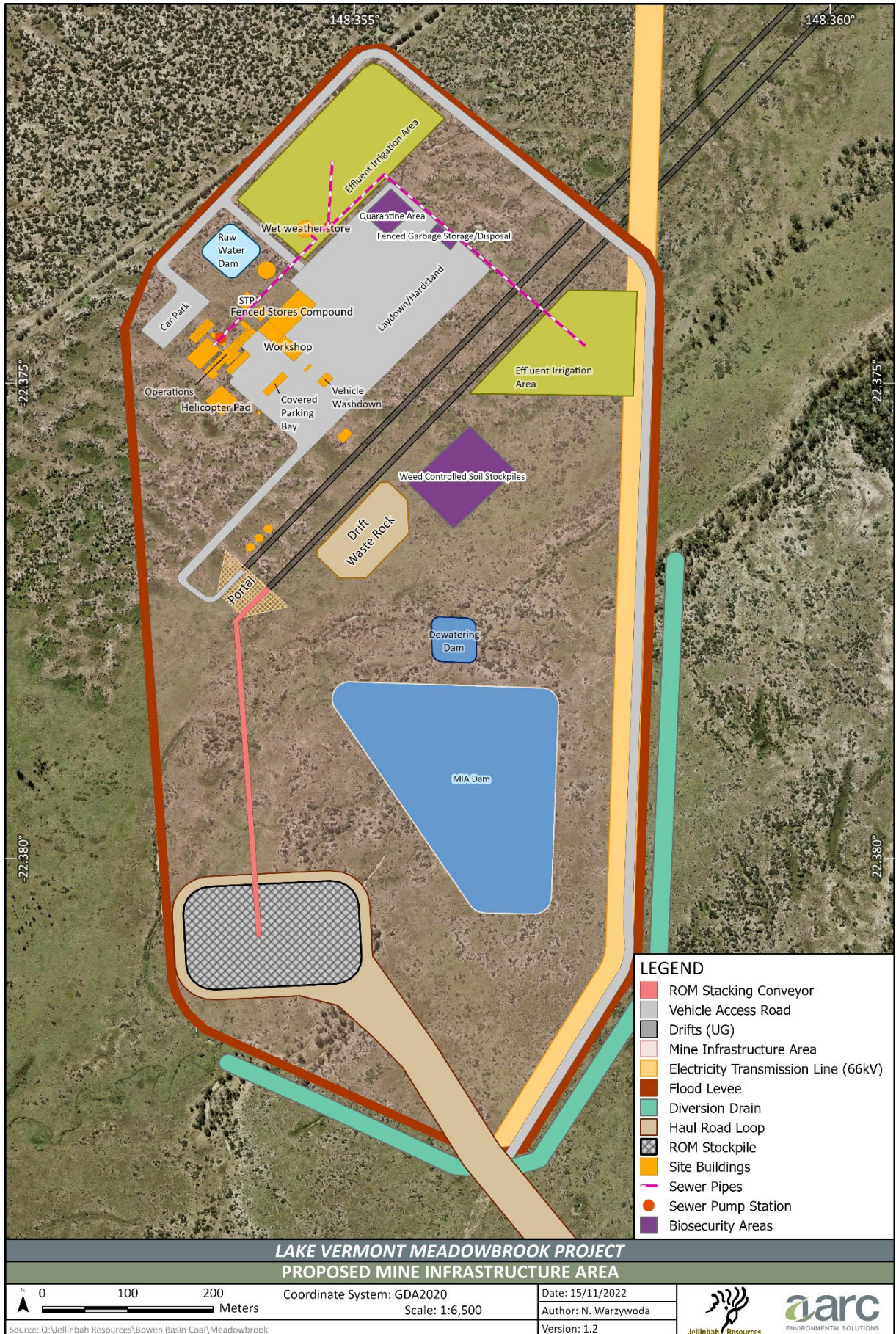

Figure 3.24: Proposed layout of the mine infrastructure area



3.3.4 Underground drifts and portal

Two underground drifts and associated portals (providing the surface entrance to the underground drift tunnels) are proposed to be constructed within the MIA (Figure 3.24). One drift will provide underground access for the transportation of personnel, mining equipment and materials, while the other drift will house the main coal clearance conveyor to convey ROM coal from underground to the ROM coal stockpile within the MIA.

A number of surface-to-seam boreholes will be developed vertically above the pit bottom area for the purposes of providing key materials to the underground (e.g. concrete supplies, stonedust, etc.). Additionally, three surface-to-seam boreholes will be developed at this location to deliver power to the underground. These boreholes will all be within the substation footprint, as shown in Figure 3.2.

Due to the long lead time involved in constructing the underground drifts (i.e. approximately 24 months), development of the portals and drifts will commence as soon as the infrastructure corridor construction enables the transport of materials and heavy equipment to the site. Construction of the water pipeline and electricity infrastructure will immediately follow the corridor development to deliver power and water to the MIA.

To enable equipment access to the portal construction site and to establish the working area for the construction of the portal, ground disturbance will be required. Impacts to ecological values resultant of clearing for MIA development (including the drift portal) are detailed in Chapter 10, Terrestrial Ecology and Chapter 21, MNES.

Portal establishment will involve the following steps:

- developing a drift construction pad;
- excavating the portal area to establish a highwall;
- pouring a concrete roadway floor and installing pre-formed concrete portal culvert structures and grouting these to the highwall;
- backfilling the portal excavation and re-topsoiling;
- installing temporary construction ventilation fans and temporary conveyors; and
- installing temporary diesel-powered generator(s) adjacent to the portal.

Diesel-powered generators adjacent to the portal will be used to supply the electricity demand of the drift construction equipment prior to the site electricity infrastructure being developed. Temporary ventilation fans will be installed to maintain suitable air quality at the working face of the drifts.

A road header will be used to excavate the drifts. Temporary conveyors will be operated to transport waste rock material from the road header to the surface where it will be deposited in the temporary stockpile near the portal entrance.

Over the 24 months of drift construction, it is estimated that 100,000 m³ of waste rock will be produced. This waste rock material will be stockpiled within the MIA (close to the portal entrance) and be utilised for Project construction activities (e.g. for the laydown areas at the MIA). Waste rock material that cannot be utilised on-site for construction and development activities will be disposed of in the proposed Project open-cut pit (as part of backfilling operations).

The indicative layout of the underground drifts once the portal has been established is shown in Figure 3.24. The underground drifts will be approximately 4.7 m high by 6.5 m wide and 2,000 m in length. Both drifts will be constructed with a gradient of 1:8 and intersect the Vermont Lower Seam at a depth of approximately 240 m (pit bottom).

The underground drifts and portal will be designed and constructed in accordance with the 'Coal Mine Safety and Health Regulation 2017'.



3.3.5 Ventilation systems

An upcast ventilation shaft will be sunk to intersect the pit bottom area at a depth of approximately 240 m. The shaft will be sunk using blind bore technology, be concrete lined and constructed in parallel with the drift construction.

The main mine ventilation fans will be positioned on the shaft collar and provide a ventilation capacity of approximately 250 cubic metres per second. The fans will be commissioned once an initial pit bottom underground roadway is driven to link the drifts to the base of the shaft. The pit bottom shaft and fans will provide sufficient ventilation capacity for the initial years of in-seam development and early longwall operation. Additional ventilation shafts will be sunk, and fan relocations will occur during the life of the underground mine to ensure adequate ventilation is maintained. Ventilation shafts will be located adjacent to existing tracks to minimise the ground disturbance required. Indicative locations of ventilation shafts are provided in Figure 3.2.

Approximately 2,500 cubic metres of *in situ* rock material will be excavated from the construction of each ventilation shaft, with excavated material to be used to build the site pad and/or bunding around the ventilation shafts. At mine closure, waste rock will be utilised to backfill ventilation shafts.

A range of equipment will be required to construct the ventilation shaft and fan assembly, including a blind bore rig and support vehicles, front-end loader and various other light and heavy vehicles.

3.3.6 Electricity supply infrastructure

As described in section 3.3.1, a 66 kV ETL will be constructed within a 20 m easement within the infrastructure corridor. The 66 kV ETL will be constructed from the existing Lake Vermont substation at the Lake Vermont Mine (adjacent to the CHPP) to a new 66 kV/22 kV electrical substation to be located above pit bottom, as shown through Figure 3.2. As required, the new electrical substation will distribute power around the MIA by above and below ground 22 kV ETLs.

The electricity supply from the electrical substation will be stepped down *via* a transformer to power the ventilation fan (6.6 kV) and supply electrical demand to the underground mine operations *via* 11 kV cables down surface-to-seam boreholes. Underground electricity supply will generally be stepped down to 3,300 V for the longwall face machinery and 1,000 V for development face machinery for other mining activities.

Diesel-powered generators and/or solar power units will be used during construction to supply electricity prior to the electricity infrastructure being developed.

3.3.7 Water supply and management infrastructure

3.3.7.1 Raw water supply pipeline

A raw water supply pipeline will be constructed within the infrastructure corridor, co-located with the ETL in a 20 m wide easement. The raw water supply pipeline will connect to the existing raw water supply pipeline at the Lake Vermont Mine that sources water from the Eungella Water Pipeline Southern Extension. The raw water supply pipeline, approximately 12 km long, will transfer raw water to a Raw Water Dam within the MIA, from which water will be pumped to a water treatment plant. Water demands for construction will be met by the capture of incidental rainfall and runoff within the Project water management system, as well as from water truck transfers from the existing Lake Vermont Mine. Water management infrastructure is described in detail in section 3.5.5.

3.3.7.2 Water treatment plant

A water treatment plant will be constructed at the MIA to provide potable water for the Project. The water treatment plant will be constructed in accordance with the National Health and Medical Research Council's (NHMRC) 'Australian Drinking Water Guidelines Paper 6 National Water Quality Management Strategy' (NHMRC 2018) and will be developed in accordance with the Queensland Water Resources Commission



(QWRC) 'Guidelines for Planning and Design of Urban Water Supply Schemes' (QWRC 1989) and relevant Australian Standards. The water treatment plant will have the capacity to provide up to approximately 30 kl/day and up to approximately 11 ML/year. Raw water will be pumped from the Raw Water Dam to the water treatment plant for treatment. Treated water will be stored in 100 kL capacity potable water tanks adjacent to the plant. Effluent from the water treatment plant will be captured and stored in a Mine Water Dam and used for dust suppression.

During construction and until the water treatment facility (and raw water supply pipeline) is operational, potable water will be trucked to the site by a local potable water supplier.

3.3.7.3 Water management infrastructure

Water management infrastructure proposed to be developed during Project construction includes the Raw Water Dam, the Dewatering Dam and the MIA Dam. These dams are proposed to be located as shown in Figure 3.24, with dam details provided in Table 3.5. Operation of these dams is discussed in Chapter 8, Surface Water.

Table 3.5: MIA Dam sizing

Storage name	Storage type	Maximum catchment area (ha)	Storage capacity (ML)
Raw Water Dam	Raw water	0.4	20
Dewatering Dam	Mine-affected water	0.4	20
MIA Dam	Mine-affected water	73	440

Water management infrastructure for the construction phase will include development of a flood protection levee around the perimeter of the MIA, as shown in Figure 3.24. The MIA flood protection levee is designed to protect infrastructure within the MIA from a 0.1% AEP flooding event. A further flood protection levee is proposed to be constructed as part of the open-cut pit development (during the Project operational phase), located as shown in Figure 3.2. Levee design and construction is discussed through Chapter 9, Flooding and Regulated Structures, Section 9.3.1.

A diversion drain is also proposed to be developed during the construction phase to support the diversion of clean water around the southern extent of the MIA levee (Figure 3.24). An additional diversion drain is also proposed to be constructed during the Project operational phase (indicatively Project Year 20) to divert clean water around the southern extent of the open-cut pit levee (refer section 3.4.1.8). Conceptual design of the diversion drain is provided through Figure 3.25, with further discussion through Chapter 9, Flooding and Regulated Structures, Section 9.3.2.

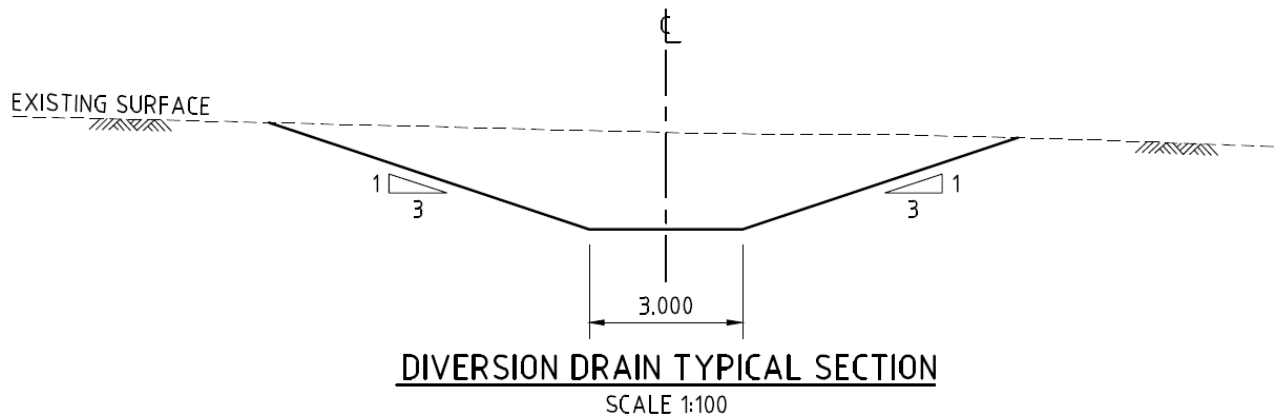

Figure 3.25: Conceptual diversion drain cross-section

3.3.8 Construction materials and equipment

The Project will support local and regional suppliers and manufacturers when possible for the supply of construction materials and equipment.

Construction materials required for the Project will include:

- bitumen;
- concrete;
- haul road base (gravel);
- pre-cast concrete structures;
- prefabricated buildings;
- structural steel and steel reinforcing;
- oversized special items; and
- other miscellaneous items.

The majority of infrastructure components (e.g. MIA buildings) will be manufactured off-site and transported to the site for assembly and installation. Delivery of construction materials to the Project will be *via* the Lake Vermont Mine Access Road and infrastructure corridor access road.

Large items that cannot be divided into smaller components will be transported on state roads under permit. When necessary, these vehicles will be accompanied by safety escorts. Equipment and fuel deliveries are anticipated to come from Moranbah or Mackay *via* Saraji Road, Golden Mile Road and the Lake Vermont Mine Access Road.

The Project construction period is expected to require approximately 115,000 m³ of road base gravel and fill for construction of the infrastructure corridor haulage road, upgrades to existing mine roads, internal access roads (e.g. at the MIA) and hardstand areas.

If suitable material for construction (such as road base gravels, clay and rock materials) is identified on-site (e.g. from the underground box-cut spoil or drift construction) it will be used for the construction of roads or lay down areas. The local Tay Glen borrow pit (south-west of the Saraji Mine), which has provided construction aggregate for the Lake Vermont Mine, will also be utilised to meet Project construction requirements. Access to the Tay Glen borrow pit is proposed *via* existing private roads and tracks under consent with relevant landowners. An assessment of construction impacts to roads is provided in Chapter 20, Transport.



The equipment fleet anticipated to be used during construction include excavators, haul trucks, dozers, drills, graders, scrapers, front-end loaders, cranes/Frannas and water trucks. The initial underground mining equipment will also be delivered to the Project during the construction stage.

3.3.9 Construction disturbance area

Approximate disturbance areas associated with the construction development footprint are provided in Table 3.6.

Construction activities will require some vegetation clearance and/or land disturbance. The location of mining infrastructure has been selected to minimise vegetation clearance. Vegetation clearance procedures have been developed for the Project and are described in Chapter 10, Terrestrial Ecology.

The locations of infrastructure corridor crossings at Phillips Creek and One Mile Creek have been selected by utilising existing light vehicle crossings to minimise damage to the bed and banks of the watercourses. No diversions of watercourses are proposed for the Project.

Table 3.6: *Approximate disturbance areas associated with construction*

Construction component	Disturbance (ha)
Infrastructure corridor and laydown areas (excluding MIA)	58.4
MIA (including levee, diversion drain and assuming 100% disturbance within MIA footprint)	73.6
ETL, substation and vehicle access (excluding MIA and infrastructure corridor)	8.8
Ventilation shafts	1.1

3.4 Operations

3.4.1 Mine resource, schedule and sequence

The Project mine layout, sequencing and mining methods have been designed or selected to maximise resource extraction and minimise resource waste, resource sterilisation and environmental impacts. The Project coal reserve will be mined using underground and open-cut mining methods.

The proposed mine schedule for the Project underground and open-cut mining operations is presented in Table 3.7. The recoverable coal reserve in the underground mining area is approximately 108.6 Mt and approximately 13.3 Mt in the open-cut mining area (Table 3.7). This provides a total recoverable ROM coal resource of approximately 122 Mt.

The Project will operate in parallel with the existing Lake Vermont Mine operations. The provisional mine schedule and sequence is based on maintaining a total Lake Vermont Mine Complex product coal output of approximately 9 Mtpa. However, Project timing may ultimately vary to take into account factors such as localised geological features, market conditions or mining economics.



Table 3.7: Provisional mine schedule—annual coal and waste production

Year	Underground mining			Open-cut mining (Satellite pit)			
	ROM coal (t)	Product (t)	CHPP rejects (t)	ROM coal (t)	ROM waste (bcm)	Product (t)	CHPP rejects (t)
1 (2026)	120,599	104,829	15,770	—	—	—	—
2	407,558	373,109	34,449	—	—	—	—
3	3,854,215	3,403,760	450,455	—	—	—	—
4	6,389,931	5,733,715	656,216	—	—	—	—
5	6,707,875	6,056,206	651,669	—	—	—	—
6	6,928,790	6,234,064	694,726	—	—	—	—
7	6,340,317	5,688,199	652,118	—	—	—	—
8	5,337,080	4,725,249	611,831	—	—	—	—
9	5,356,817	4,468,218	888,599	—	—	—	—
10	4,868,204	4,059,046	809,158	—	—	—	—
11	5,446,513	4,498,854	947,659	—	—	—	—
12	3,931,421	3,282,333	649,088	—	—	—	—
13	4,861,426	4,108,503	752,923	—	—	—	—
14	5,377,038	4,539,002	838,036	—	—	—	—
15	5,931,230	5,049,339	881,891	—	—	—	—
16	4,490,033	3,928,561	561,472	—	—	—	—
17	4,739,102	4,181,096	558,006	—	—	—	—
18	5,065,826	4,458,430	607,396	—	—	—	—
19	4,577,298	4,006,933	570,365	—	—	—	—
20	4,733,743	4,085,390	648,353	258,707	13,532,224	200,436	58,271
21	5,725,404	4,820,442	904,962	1,066,768	15,963,723	844,570	222,198
22	4,410,978	3,594,433	816,545	1,321,576	17,578,874	1,072,284	249,292
23	2,965,948	2,322,704	643,244	1,276,587	17,621,022	1,063,526	213,061
24	—	—	—	1,401,996	17,074,784	1,136,094	265,902
25	—	—	—	1,488,154	17,249,295	1,157,223	330,931
26	—	—	—	1,442,902	17,832,792	1,034,341	408,561
27	—	—	—	1,316,800	17,822,767	956,998	359,802
28	—	—	—	1,451,066	17,108,187	1,148,838	302,228
29	—	—	—	1,924,539	12,755,867	1,577,244	347,295
30	—	—	—	395,669	1,106,802	324,386	71,283
Total	108,567,347	93,722,417	14,844,931	13,344,763	165,646,337	10,515,939	2,828,824



3.4.1.1 Underground mining schedule and sequencing

Figure 3.26 shows the planned mining sequence for the underground mining area. The primary underground target seam is the Vermont Lower Seam that extends across the whole underground mining footprint. Underground mining of coal reserves will commence in the Vermont Lower Seam in Project Year 1 (indicatively 2026) and continue for approximately 23 years. The overlying Leichhardt Lower Seam, which is a secondary underground target seam, is only present across the northern half of the underground footprint.

The Vermont Lower Seam occurs at depths ranging from approximately 150 m in the south-west of the underground mining footprint to approximately 500 m in the north-east. The Leichhardt Lower Seam occurs at depths ranging from approximately 250 m in the west of the underground mining footprint to approximately 500 m in the far north-east of the mining area.

The development of the underground main headings and gate roads is anticipated to commence in Project Year 1 after construction of the drifts has been completed. Figure 3.26 shows the progression of development roadways and mining over the life of the mine. Continuous miner units will be utilised to drive the in-seam access headings to enable longwall operations to commence. Approximately 22 months of initial in-seam development using continuous miners is planned before the longwall commences operation.

It is planned to extract the southern longwall panels first by progressing from west to east (Figure 3.26). As the longwall completes the southern panels in the Lower Vermont Seam, in-seam development work will commence in the northern panels in the overlying Leichhardt Lower Seam. Access from the Vermont Lower Seam up to the Leichhardt Lower Seam will be *via* inter-seam drifts. Upon completing extraction of the southern Vermont Lower Seam panels, the longwall will commence mining the northern Leichhardt Lower Seam panels. Once the northern Leichhardt Lower Seam panels have been extracted, mining will recommence in the Vermont Lower Seam to extract the northern Vermont Lower Seam panels. The general mining sequence and annual mining progress plots are shown on Figure 3.26.

During Project feasibility studies, a number of underground mining alternatives have been assessed prior to defining the final longwall layout. Project alternatives are discussed in section 3.6.

3.1.2.1 Open-cut mining schedule and sequencing

The planned mining sequence for the open-cut pit is shown in Figure 3.27. Coal reserves in the open-cut pit will be mined for approximately 11 years (Table 3.7) (i.e. starting in Project Year 20 and finishing in Project Year 30). Open-cut mining of coal reserves from the Leichhardt Lower, Vermont and Vermont Lower Seams will occur within the open-cut pit.

The open-cut will be a terrace mining operation that will initially commence in the south and progress north to the centre of the mining area (Figure 3.27). Mining will then relocate and commence in the north and progress to the south (Figure 3.27). This mining sequence and associated backfilling will result in the final rehabilitated pit landform providing a post-mining land use of grazing (consistent with the pre-mining land use). This progression also ensures that no pit void is retained post-mine closure. Rehabilitation of the Project will be provided for through a PRCP (Appendix B, Progressive Rehabilitation and Closure Plan), as detailed in Chapter 6, Rehabilitation.

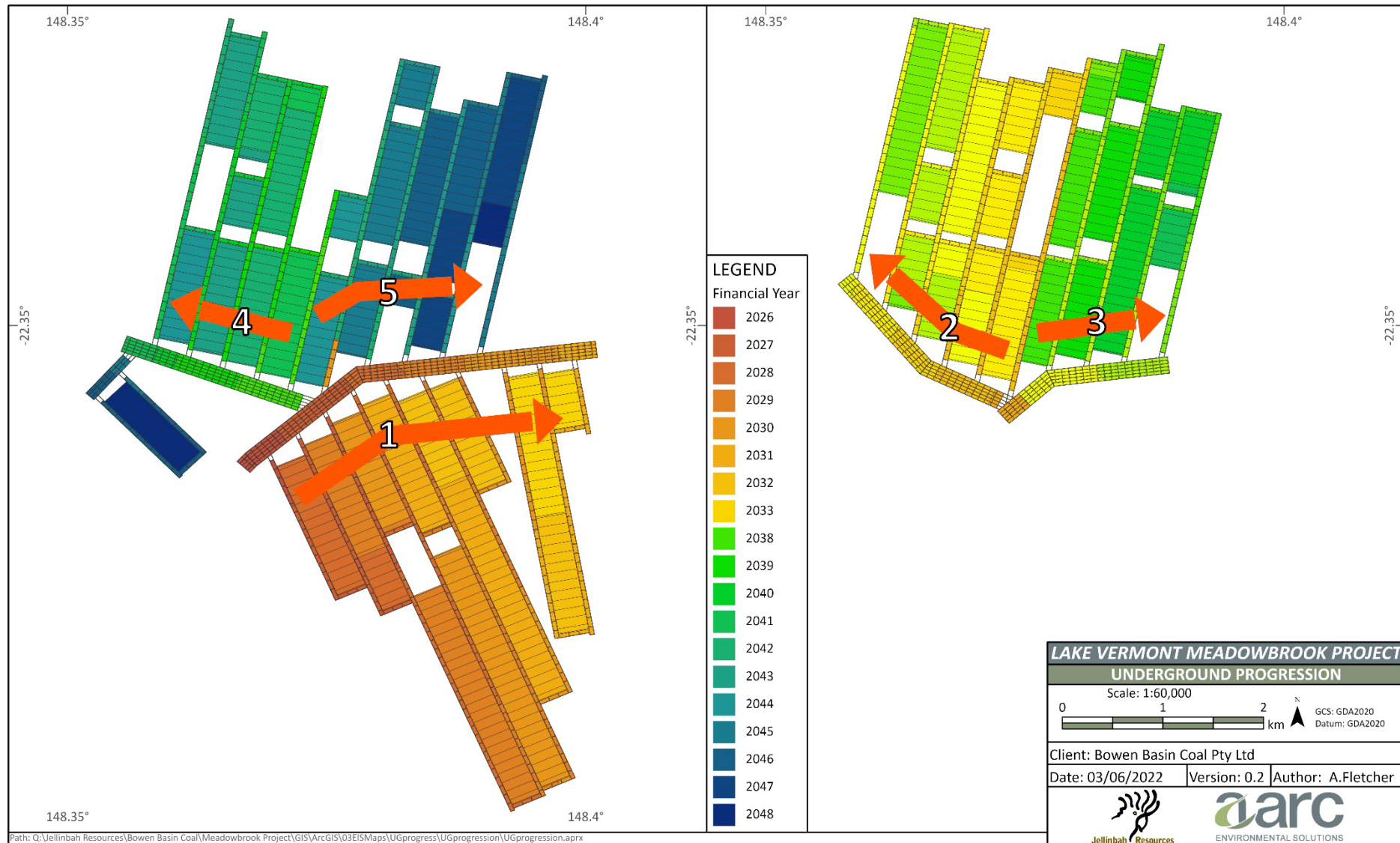

Figure 3.26: Indicative mine progression plans—underground mining



Figure 3.27: Indicative mine progression plan—open-cut pit mining



3.1.1.2 Lake Vermont Meadowbrook Complex schedule

Figure 3.28 shows the life of mine production profile for the Lake Vermont Meadowbrook Complex (i.e. the existing Lake Vermont Mine and the Lake Vermont Meadowbrook Project). As illustrated by this figure, the Project addresses the forecast reduction in coal production that will occur at the existing Lake Vermont Mine by combining output from the existing open-cut operations and the Project extension.

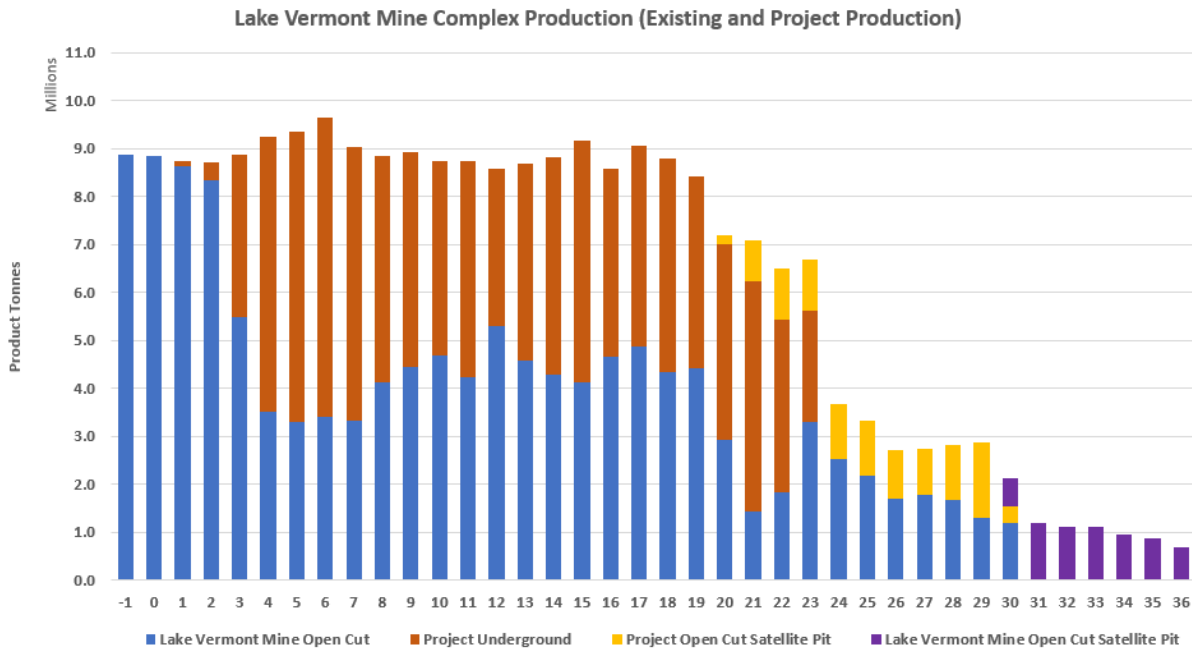

Figure 3.28: Lake Vermont Meadowbrook Complex—life of mine production profile

Without the Project, mining activity at the existing Lake Vermont Mine will gradually decline from 2024, with further sharp decreases (to approximately 4 Mtpa and less) from 2028 (Project Year 3) until the end of the mine life (Figure 3.28). The Project proposes to provide additional product coal to augment the reduced open-cut output and maintain production levels at approximately 9 Mtpa from Project Year 3 (indicatively 2026) through to Project Year 22 (indicatively 2048). As the Project underground extension reaches its final years, the proposed open-cut satellite pit will commence (in Project Year 20), further supplementing existing operations, albeit with production levels continuing to tail off until Project mining completion (in Project Year 30). Mining at the existing Lake Vermont Mine will continue for approximately six years following completion of the proposed Project through the mining of the (already approved) Lake Vermont Mine open-cut satellite pit (Figure 3.28).

While progressive rehabilitation will occur throughout the life of the Project, final rehabilitation and mine closure will occur in conjunction with final mining. Backfilling of the open-cut pit is scheduled to be completed in Year 35 (indicatively 2060), with achievement of a stable post-mining land use (grazing) anticipated in Year 53 (indicatively 2078). Further details of the rehabilitation and closure of the Project are provided in Chapter 6, Rehabilitation.

Figure 3.29 to Figure 3.35 show the general arrangement of the Project in Project Years 2, 7, 12, 17, 22, and 27, and end of mining, together with the progress of the existing Lake Vermont Mine. It is noted that Project Year 7 (as one of the peak underground production years) and Project Year 22 (as a year involving overlap of both the underground and open-cut developments) are the years that have been selected for the modelling of potential impacts on environmental values, such as air quality and noise. Assessments of the potential Project air quality and noise impacts are provided in Chapter 13, Air Quality and Chapter 14, Noise and Vibration.

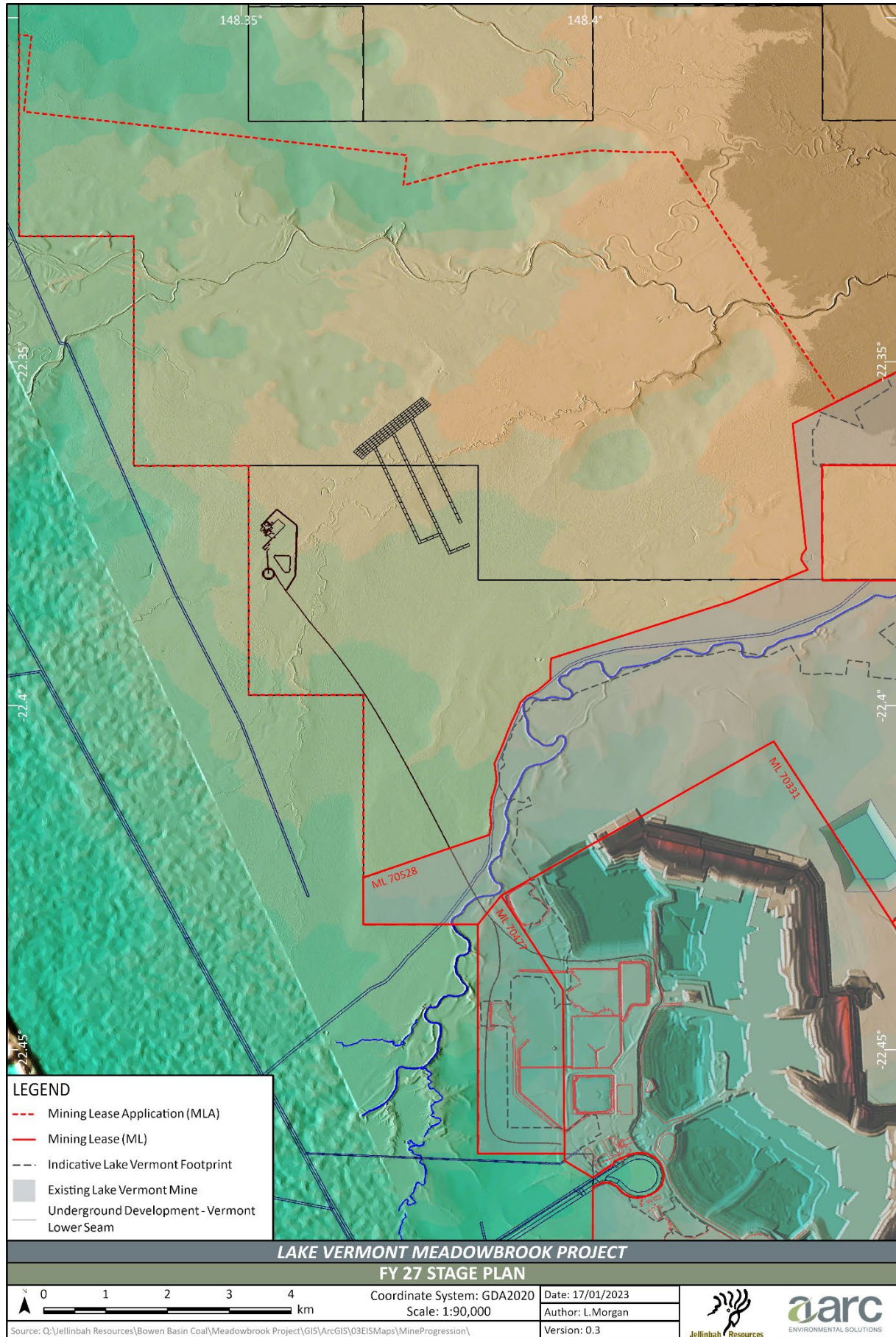

Figure 3.29: Mine stage plan—Project Year 2

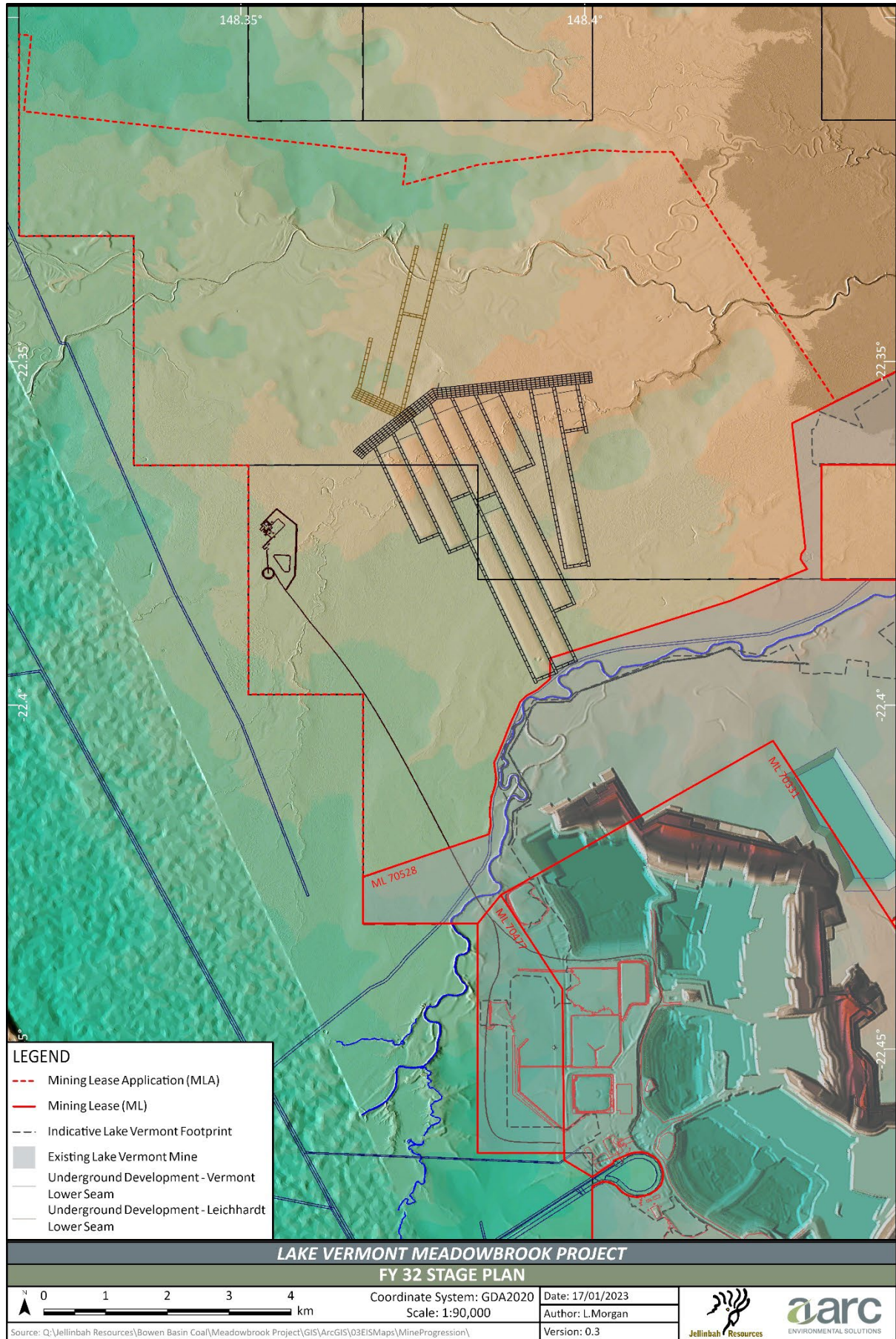

Figure 3.30: Mine stage plan—Project Year 7

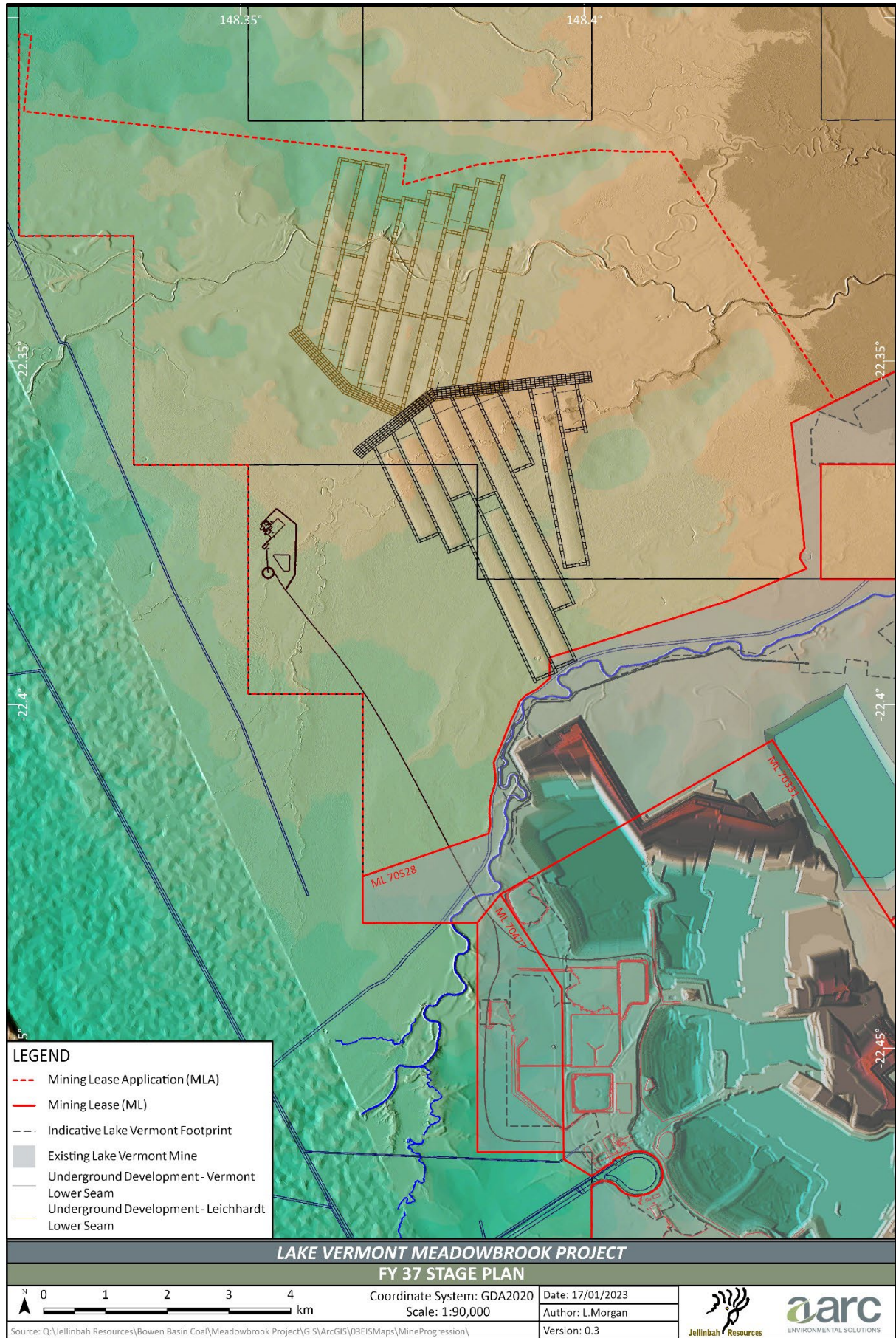

Figure 3.31: Mine stage plan—Project Year 12

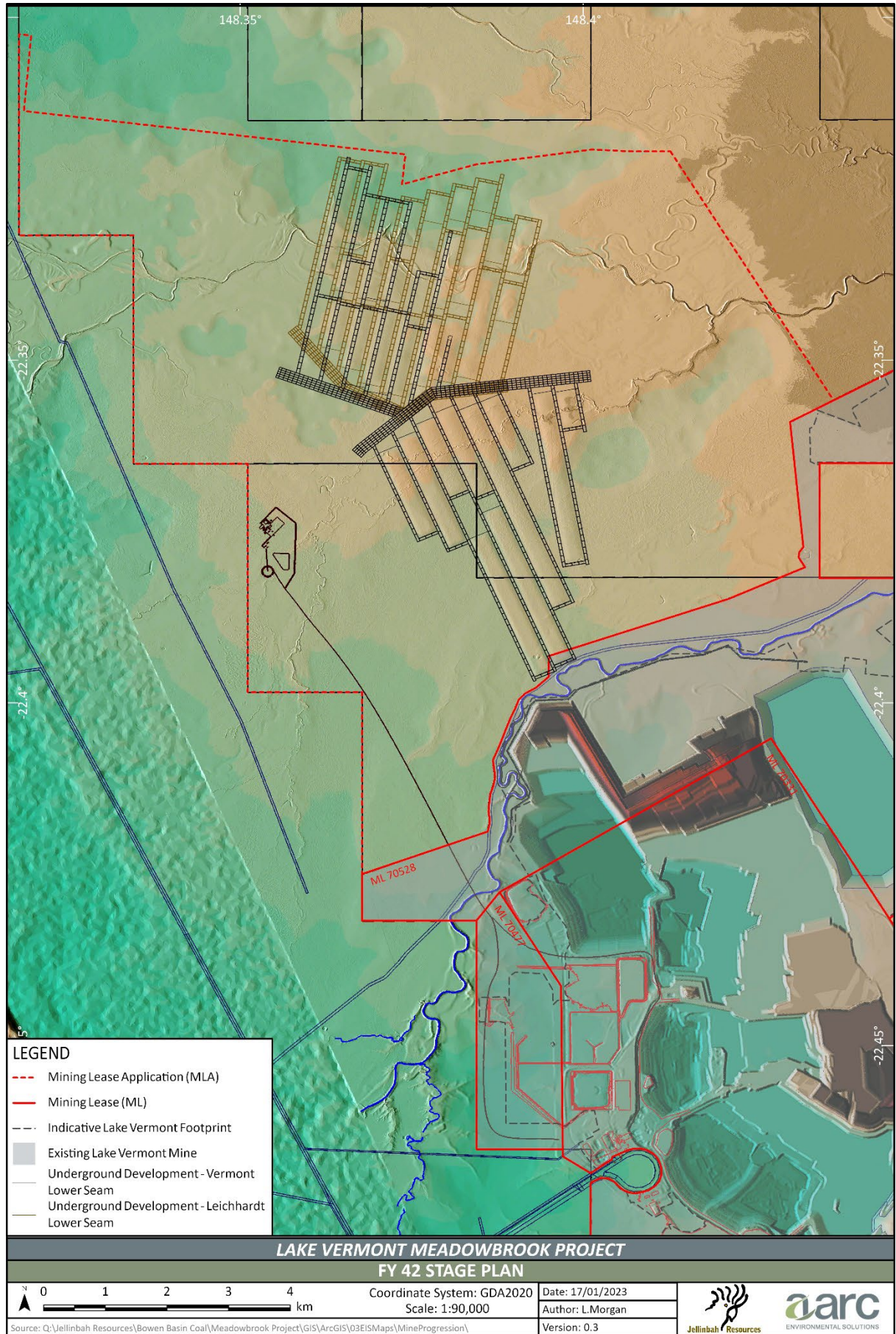

Figure 3.32: Mine stage plan—Project Year 17

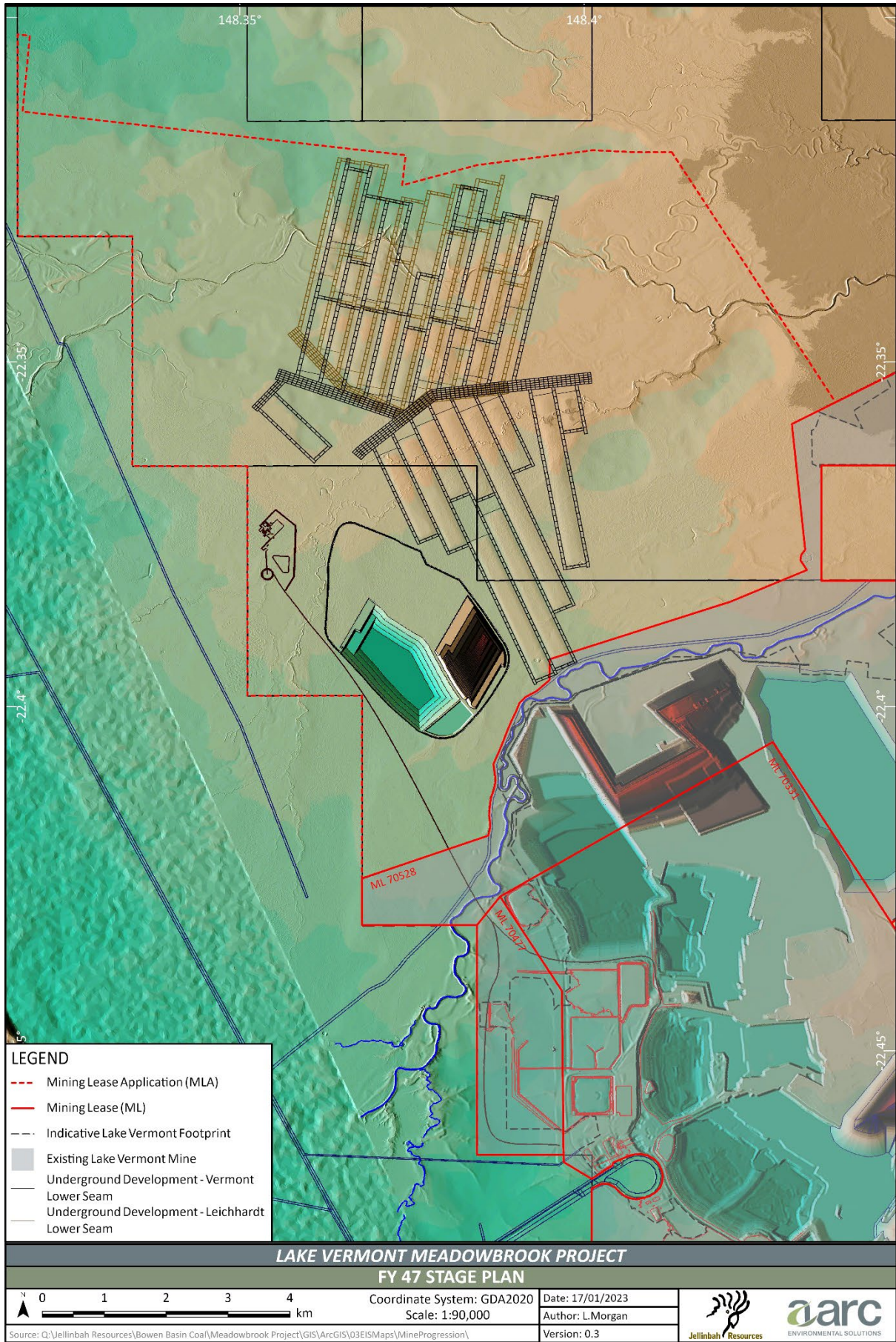

Figure 3.33: Mine stage plan—Project Year 22

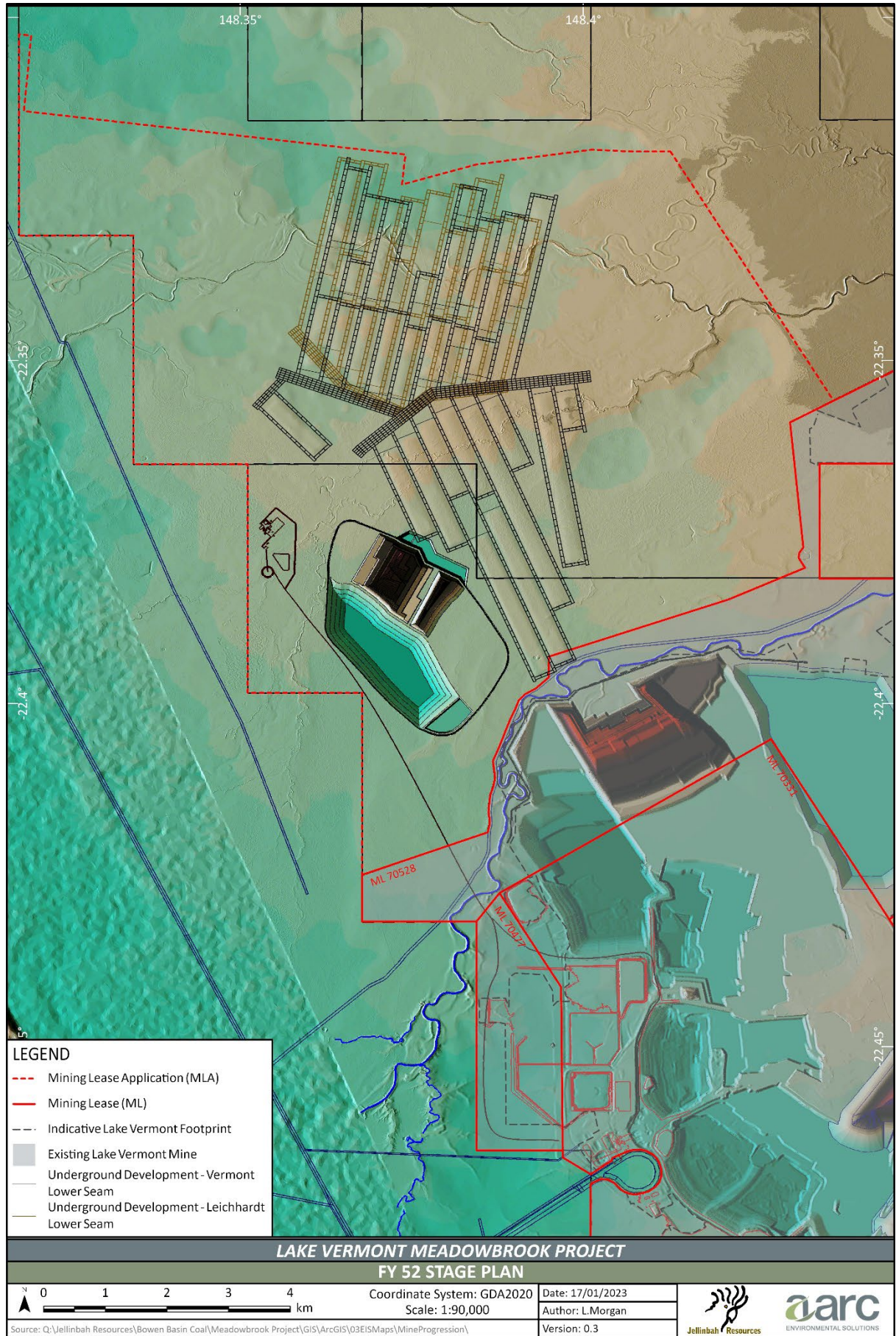

Figure 3.34: Mine stage plan—Project Year 27

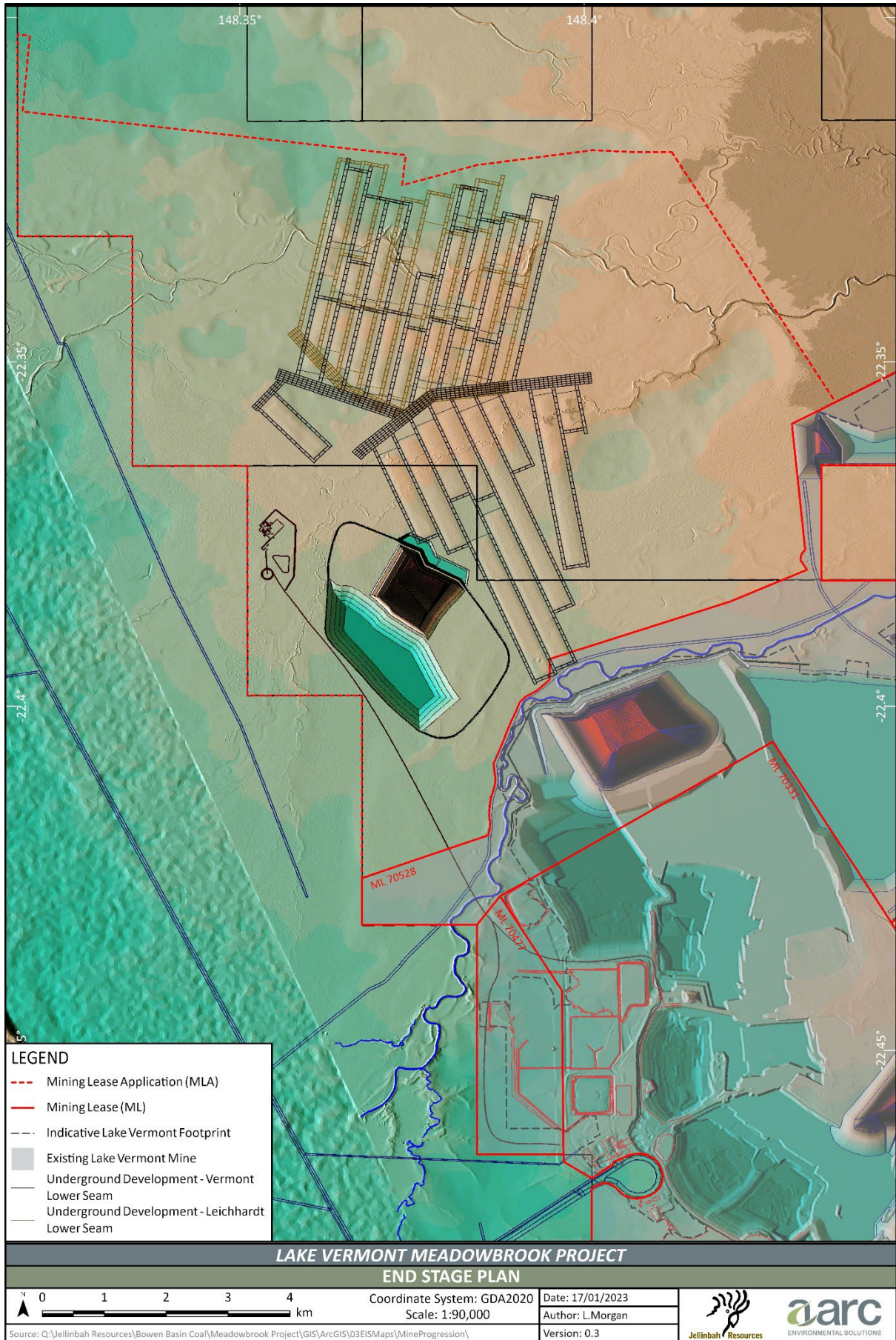

Figure 3.35: Mine stage plan—end of all mining



3.4.1.2 Mine access and development works

Access to the underground will be *via* the main drifts located within the MIA (Figure 3.24). The MIA has been located in an area that enables efficient access to both the proposed underground and open-cut developments. Matters considered when locating the MIA are discussed in section 3.6.5.

Construction of the underground drifts and portal is described in section 3.3.4. Following the completion of portal/drift construction, underground access roadways will be developed using continuous miners. Underground main roads (main headings) will be developed towards the east and run through the approximate centre of the underground mining area. The main headings will provide the primary access, ventilation and roadways for housing the main trunk coal conveyors (Figure 3.2). Each longwall panel will be formed by developing gate roads (the tail gate and main gate roads) that extend from the main heading to the limits of the mine footprint. The gate roads will consist of two parallel roadways driven using continuous miners (Figure 3.36), with each roadway being approximately 5.0 m wide and 3.2 m in height. The headings will be connected approximately every 100 m by driving a cut-through from one heading to the other. This will leave a series of coal pillars along the length of the gate road that will support the overlying strata (Figure 3.36).

The development of the underground main headings and gate roads is anticipated to commence in Project Year 1 after construction of the drifts has been completed. Figure 3.26 shows the progression of the development roadways and mining over the life of the mine.



Figure 3.36: Longwall Mining Method Schematic

3.4.1.3 Longwall mining operation

Conventional longwall coal mining methods will be used to extract coal from the underground mining area.

Longwall extraction has been planned for the Vermont Lower Seam and the overlying Leichhardt Lower Seam. Longwalls in the Vermont Lower Seam have been designed with a solid coal face length of approximately 300 m. In the shallower area south of the main headings, the width of the gate road chain pillars will vary from between 35 m to 40 m (solid). In the deeper area north of the main headings, the solid dimension of the chain pillars will vary between 45 m to 50 m. The extraction height of the longwall will range between approximately 3 m to 4.8 m for the Vermont Lower Seam and increase from west to east.



Longwalls in the Leichhardt Lower Seam will also have face lengths of up to approximately 300 m (solid). Three panels have been narrowed to 270 m wide (solid) to maximise recovery between faults. The gate road chain pillars in the Leichhardt Lower Seam are 45 m wide (solid). The extraction height of the Leichhardt Lower Seam will be approximately 3.0 m to 4.8 m.

The longwall unit will utilise a shearer to progressively cut a slice of coal from the coal face, and the broken coal will then be transferred to the main gate conveyor *via* an armoured face conveyor. The longwall unit will utilise a series of hydraulically powered roof supports to provide a safe working environment for the shearer and the machine operators. Once each slice of coal is removed from the longwall face, the hydraulic roof supports will be progressively advanced allowing the immediate overlying roof strata to collapse behind the rear shields of the longwall supports (referred to as forming the 'goaf') (Figure 3.36).

Figure 3.36 illustrates the development of the roadways prior to mining and the longwall mining method. To start each new longwall panel, the longwall unit is disassembled and recovered from the take-off position of the previous longwall and transported to and re-assembled along the installation roadway of the next panel. This longwall relocation process takes approximately one month.

ROM coal extracted by the longwall unit will be conveyed along the gate road *via* the main gate conveyor and transferred onto the trunk conveyor system that will run the length of the main headings and conveyor drift. On reaching the surface, the ROM coal will be conveyed directly to the ROM coal stockpile in the MIA. ROM coal handling and processing is described in section 3.4.2.

3.4.1.4 Major underground equipment and mobile fleet

The major underground equipment and mobile fleet anticipated to be required for the Project's underground mining operations is provided in Table 3.8.

Table 3.8: Major underground equipment and mobile fleet

Description	Estimated quantity
Longwall face unit	1
Development face units	3
Load haul dump (LHD) transporters	8
Man transporters	12
UG grader	1
UG mine dozer	1
Main ventilation fan system	1
Mains conveyor system to surface	1
Gate road conveyor systems	3
CAT992 loader (MIA ROM coal stockpile and new ROM pad at Lake Vermont Mine)	2
CATD11 dozer (MIA ROM coal stockpile and new ROM pad at Lake Vermont Mine)	1
Service truck (for maintenance of surface equipment)	1
Road trains (for transport of ROM coal from ROM coal stockpile area to new ROM pad at Lake Vermont Mine)	5
Light vehicle	25



3.4.1.5 Coal seam gas management

Incidental coal seam gas is present in the Rangal coal seam measures, and gas drainage will be required to reduce the in-seam gas contents to below outburst thresholds to ensure safe mining conditions. A Gas Drainage Management Plan will be developed prior to mining commencement that will include the following operating and management details:

- pre-drainage of the coal seams prior to underground mining;
- dilution of methane *via* the mine ventilation system throughout mine operations; and
- post-drainage of goaf areas following longwall extraction.

As part of the feasibility studies, the Proponent has undertaken an initial assessment of the gas reservoir characteristics to understand the extent of the gas drainage and mine ventilation options.

Gas pre-drainage will include the use of ‘surface-to-seam’ (SIS) as well as ‘underground in-seam’ (UIS) drainage drilling. Gas drainage is intended to reduce the in-seam gas content to below outburst thresholds and to a level where the mine ventilation system can adequately dilute the residual gas levels. Once coal mining operations commence, UIS pre-drainage will form the primary pre-drainage strategy.

SIS gas drainage

SIS gas pre-drainage involves the use of gas drainage wells that are connected from the surface to the underground coal seam. The use of lateral and vertical wells are used in combination as part of the Project SIS drainage program (Figure 3.37). Lateral wells are drilled along the coal seam and intersect vertical wells at the end hole. The vertical well, in connection with the lateral well, is used to collect gas from the intersected coal seam and deliver it to the surface (Figure 3.37).

Gas drainage wells will be developed over each panel as mining progresses through the underground area, with relocatable surface control equipment to be transported to new locations as required. On the surface, the SIS gas drainage well head will be sealed; this is where the water and gas are then separated using a separation unit. The water will be separated and distributed to the Dewatering Dam within the MIA via cross surface pipelines. The groundwater extracted as part of the SIS gas drainage process forms part of the overall underground water inflows estimates, as included within the site water balance model. Gas will flow into monitoring equipment and control equipment that will generally consist of flame arrestors, non-return valves, filter boxes, control boxes and fire suppressors positioned on a relocatable skid (Figure 3.38). Once the gas has flowed through the control and monitoring equipment, it can be piped to its final destination. This may be *via* several methods, such as venting, flaring or on-site power generation.

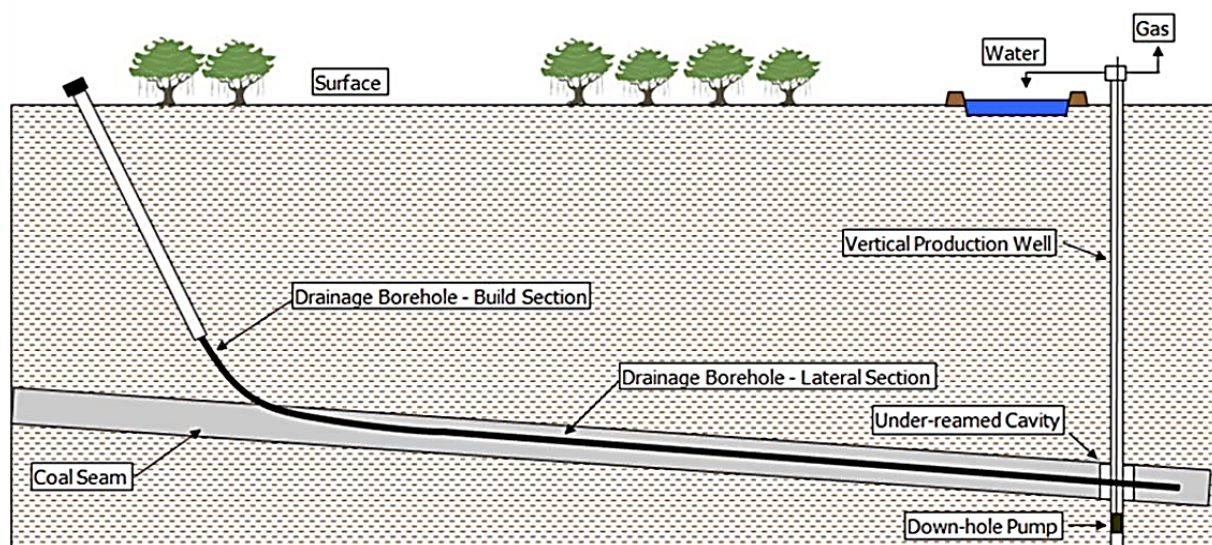

Figure 3.37: SIS Gas Drainage Underground Installation Example.



Figure 3.38: Example SIS gas drainage relocatable skid.

UIS gas drainage

UIS gas pre-drainage will generally include a borehole riser drilled from the surface down to the coal seam. It is connected at the bottom of the hole to the underground gas infrastructure that consists of gas/water separators and gas pipelines.

On the surface, the UIS gas riser is typically set up in a similar configuration to the SIS gas drainage equipment. This includes monitoring equipment and control equipment that generally consists of flame arrestors, non-return valves, filter boxes, control boxes and fire suppressors positioned on a relocatable skid, with the addition of a venturi to assist in the extraction of gas. Figure 3.39 shows a typical UIS venturi surface skid.

Placement of the UIS drainage vertical risers depends on underground workings and mining schedules. Generally, the risers would be positioned along the panel roadways and advanced as mining progresses.



Figure 3.39: Example venturi skid equipment.

Management of mine gas

Once gas drainage and mining operations commence, sufficient site-specific gas well operational performance data will be obtained to assess the viability of on-site power generation as an alternative to flaring. Any potential future uses of mine gas would be discussed with the holder of the overlapping petroleum tenure.

It is proposed that gas captured *via* pre- and post-drainage systems will be flared. Flaring incidental mine gas significantly reduces greenhouse gas emissions. Project greenhouse gas emissions are considered in detail in Chapter 13, Air Quality.

Flaring stacks are typically situated at a set distance away from gas drainage equipment and infrastructure where they would be connected *via* gas pipelines to pre- or post-gas drainage skids. An example of a flaring stack proposed to be used by the Project is shown in Figure 3.40.

Ventilation air methane

As a standard requirement in underground coal mines, ventilation systems will be installed at the commencement of the mine and will progress with the mine as it develops. Due to residual coal seam gas following pre-drainage, the ventilation system will generate ventilation air methane that will be vented to the atmosphere. Project greenhouse gas emissions are considered in detail in Chapter 13, Air Quality.



Figure 3.40: Example flare installation.

Post-mine gas drainage

The roof behind the longwall will collapse after the coal has been forming the goaf. In the goaf, there may be remnant coal remaining, or upon fracture of the surrounding strata after the roof has collapsed, it may connect to additional coal seams. This will cause goaf gas to build up behind the longwall. Post-mining gas drainage may, therefore, be required to ensure that gas levels are controlled and remain within regulated limits in the longwall ventilation circuit. Post-mine gas drainage will utilise UIS drainage infrastructure and not require additional surface disturbance.

The gas can be drained *via* vertical gas wells that are drilled into the strata above the coal seam that does not form part of the goaf. As the goaf is formed and roof fractures are created, the gas will drain *via* the vertical gas wells to the surface infrastructure. An installation example of the vertical goaf gas wells is detailed in Figure 3.41.

Surface disturbance for gas drainage

Surface disturbance will be required to facilitate SIS gas drainage activities. Access to the surface of each longwall panel will be required here, with this predominantly achieved through the existing track network that exists across the Project site. Additional track access will be required, however, to support access to panels in the north-west of the underground mining area. One new track is proposed to facilitate this access, which is included in the proposed disturbance for the Project (Figure 3.2). Further access *via* the existing and proposed track network will be achieved by slashing (as opposed to blade clearance) without new ground disturbance.

At any one time, however, small areas (<2 ha) are likely to be disturbed for drilling and gas control equipment establishment and operation. Gas drainage will avoid areas of Brigalow TEC, Poplar Box TEC and areas of conservation of significant fauna habitat and vegetation in proximity to watercourses.

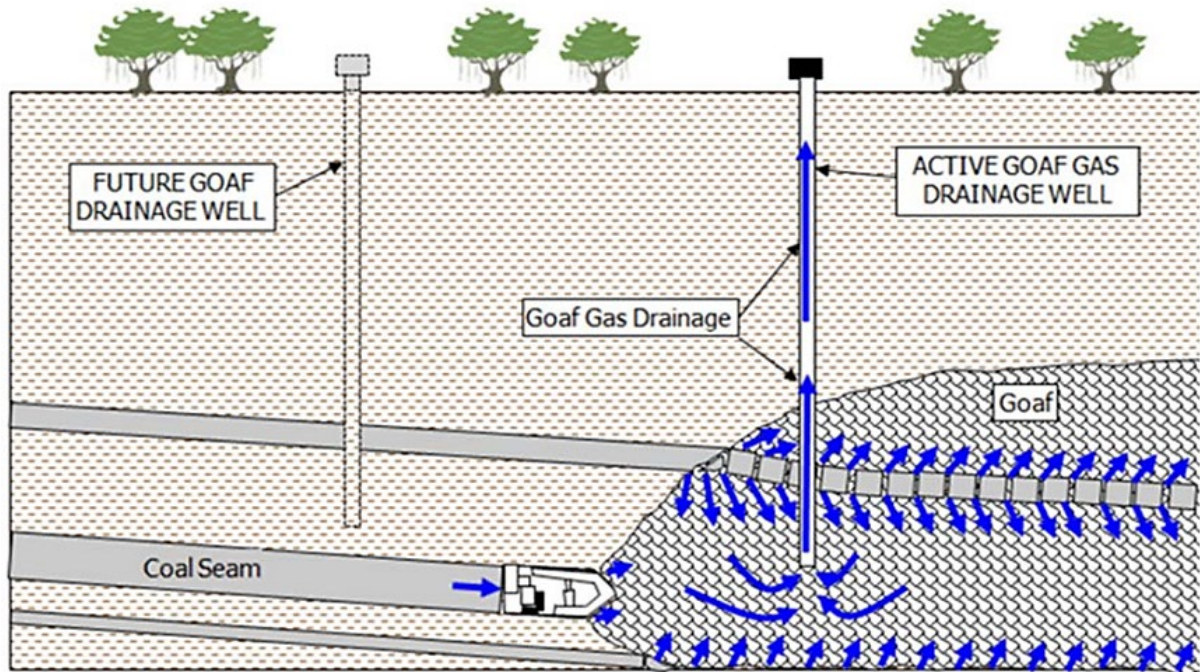

Figure 3.41: Vertical goaf gas wells—example installation.

There is some flexibility with the location of gas pre-drainage infrastructure, with wells generally able to be situated to avoid ecologically sensitive areas. The location of gas post-drainage infrastructure and wells are not quite as flexible, as they need to be placed along the edge of mining panels. However, a degree of latitude will exist when locating boreholes to minimise environmental impacts. The footprint of gas drainage activities will, therefore, be consistent with typical exploration disturbance while also being temporary (short-term).

Decommissioning and rehabilitation

Once mining has advanced beyond the location of a gas drainage vertical well or borehole, that hole will be decommissioned and rehabilitated within three months. The decommissioning and rehabilitation process will involve:

- disconnecting and removing all surface and downhole equipment;
- plugging/capping the hole so that there is no connection with the surface atmosphere;
- removing any protruding casing/piping to below ground level;
- ensuring the surveyed location of the hole is recorded; and
- rehabilitating the site in accordance with the Project PRCP (Appendix B, Progressive Rehabilitation and Closure Plan).

After wells are decommissioned, general rehabilitation practices will utilise vegetation and topsoil previously set aside from site clearing. Each pre-drainage surface borehole site will be active for a few years as the drainage operation periodically relocates with the progressive advancement of the mining faces. After this time, they will be progressively rehabilitated. Post-drainage goaf holes will be rehabilitated more frequently and align with the completion of each longwall block. The goaf holes will be decommissioned, capped and rehabilitated as part of the requirements of the longwall sealing management procedures.

3.4.1.6 Mine dewatering

Groundwater that drains from coal seams and the surrounding rock mass will accumulate in the underground workings prior to being pumped to the surface *via* the access drifts. While local groundwater resources are



notably of poor quality (i.e. highly saline), water pumped to the surface will be significantly diluted from the raw water sent underground for dust suppression. Modelled water quality is, therefore, indicative of a suitable salinity to utilise this water for dust suppression and processing activities. Notwithstanding this, the proposed water management system will include a Dewatering Dam (Figure 3.24). From here, water may be pumped into the adjoining MIA Dam (for further dilution) and utilised for dust suppression or sent back to the Lake Vermont Mine to support processing requirements. Any excess water may also be stored within existing (approved) voids at the Lake Vermont Mine. Further details of the Project water management system are provided in Chapter 8, Surface Water.

3.4.1.7 Open-cut satellite pit

The Project's open-cut satellite pit is north of Phillips Creek and south of One Mile Creek in the area south-west of the MIA (Figure 3.2). Initially, three open-cut satellite pits were considered for the Project; however, as discussed in section 3.6, two have been discounted based on environmental considerations.

The proposed open-cut satellite pit seeks to mine the Vermont Lower, Vermont and Leichhardt Seams. The width and length of the open-cut pit is approximately 800 m by 3,100 m, respectively. An overall average strip ratio of 14 (bcm waste rock): 1 (t ROM coal) is estimated for the open-cut satellite pit. Given the relatively steep floor grade, the pit has been designed as a terrace mining operation. The extent of the pit lies within the flood plain of Phillips Creek in the south and One Mile Creek in the north. Consequently, mining operations will commence at the southern and northern extremities of the defined mining area and progress towards the centre of the pit, with progressive backfilling ensuring no void is retained within a floodplain. Indeed, the rehabilitated pit area will achieve a post-mining land use. Project rehabilitation is addressed in detail in Chapter 6, Rehabilitation.

Open-cut batters will generally have slopes of 63 degrees (2V:1H). The maximum depth of the open-cut will be approximately 130 m in the central area of the open-cut pit. After backfilling, however, the landform will have a total depth of approximately 33 m.

The placement of the initial box-cut and mine sequencing has been determined by the need to:

- utilise a terrace mining technique to manage the steep floor grades;
- locate the final void in a location outside of the floodplain; and
- minimise the haul distance to overburden dumps to reduce noise and air emissions.

The open-cut mining schedule is provided in Table 3.7 and described in section 3.4.1. Progress plots are shown in Figure 3.27. General arrangements for the open-cut satellite pit that match the schedule of the Lake Vermont Meadowbrook Complex are shown in Figure 3.33 and Figure 3.34 (Project Year 22 and Project Year 27, respectively).

3.4.1.8 Open-cut water management

A temporary levee will be constructed around the proposed open-cut pit area to protect infrastructure from floodwater ingress. The flood levee is proposed to be constructed in advance of open-cut mining operations (indicatively Project Year 20).

The open-cut flood levee will provide protection for a maximum 0.1% AEP design flood event and will be considered a regulated structure. Flood levee design and construction is discussed through Chapter 9, Flooding and Regulated Structures.

A diversion drain will be constructed around the south-eastern corner of the open-cut footprint to divert clean water (from a minor drainage line) around the disturbed area (refer Figure 3.2). This diversion drain will be constructed in parallel with the open-cut pit levee (indicatively Project Year 20). A conceptual diversion drain cross-section is shown in Figure 3.25.

Sediment dams will be constructed within the open-cut satellite pit footprint to assist in managing runoff within this area (including from waste rock emplacements) (Figure 3.27). As runoff is expected to be



relatively benign, sediment dams will be designed to discharge to the environment (after the settlement of suspended sediment), with minimal impact to downstream water quality or the receiving environment expected. Sediment dams will be constructed to contain a 1 in 10-year ARI 24-hour rainfall event. All sediment dams will be removed and rehabilitated as part of mine closure. Design and operation of sediment dams is discussed in Chapter 8, Surface Water.

The final landform design for the Project prevents water ingress into the final rehabilitated pit landform (which will present as a surface depression) in the event of a 0.1% AEP flooding event. The post-closure flood model indicating the location of the rehabilitated pit landform is shown in Figure 3.42. Rehabilitation of the Project is detailed in Chapter 6, Rehabilitation.

3.4.1.9 Mining method

Due to the steeply dipping geology of the open-cut pit coal resource, conventional hydraulic excavators and rear dump trucks will be used in a terrace style mining operation. The terrace mining method, with advancing in-pit dumps, is an established mining method. Terrace mining utilises horizontal mining benches (flitches) that are removed by excavator/truck fleets. Coal and waste are removed as they are encountered, with mining progressing down and across benches. The overburden (waste) is placed in out-of-pit waste rock emplacements or used to backfill the void behind the advancing operations.

Working benches 200 m wide will provide room across the pit width to have multiple coal mining faces exposed at any one time. A main 50 m wide sidewall haul-back road is proposed to be constructed along the western wall. Other haul-back roads will be on the floor of the deposit and along the natural surface level. The face ramp design will be repeated every 200 m, with face ramps connecting to the sidewall road to provide continuous access to the pit bottom for coal and waste haulage. The mining flitches are expected to be 3 m to 5 m deep. In steeper areas, extra equipment, such as D10 dozers or small backhoes, will be utilised to move material onto the floor to allow efficient excavation of the waste/coal interface and minimise coal loss.

Waste will be hauled to out-of-pit waste emplacements, while coal will be hauled to the ROM coal stockpile.

A summary of typical open-cut mining activities and sequences is provided below:

- **Vegetation clearing:** Most of the disturbance footprint that is associated with the open-cut pit and flood levee is clear of remnant or high-value regrowth vegetation and is characterised by cleared grazing land. Remnant vegetation in the north of the disturbance footprint will be removed in accordance with specific vegetation clearance procedures to be developed for the Project.
- **Topsoil stripping and handling:** When stripped topsoils cannot be used directly for progressive rehabilitation, the topsoil will be stockpiled separately. Specific soil management, stockpiling and re-application procedures will be developed for the Project.
- **Overburden removal:** Overburden will primarily be removed by excavators and haul trucks along with supporting dozers and used for backfilling the void behind the advancing operations or placed in out-of-pit waste rock emplacements. Conventional drill and blast techniques using standard rotary drills will be used for the blasting of competent overburden and interburden material. Small quantities of underburden may also be drilled and blasted as required for geotechnical stability. Standard commercial products will be used with the principal blasting agent, ammonium nitrate and fuel oil (ANFO).
- **Coal mining and ROM coal handling:** Coal mining will involve excavators loading ROM coal into haul trucks for haulage to the ROM coal stockpile.

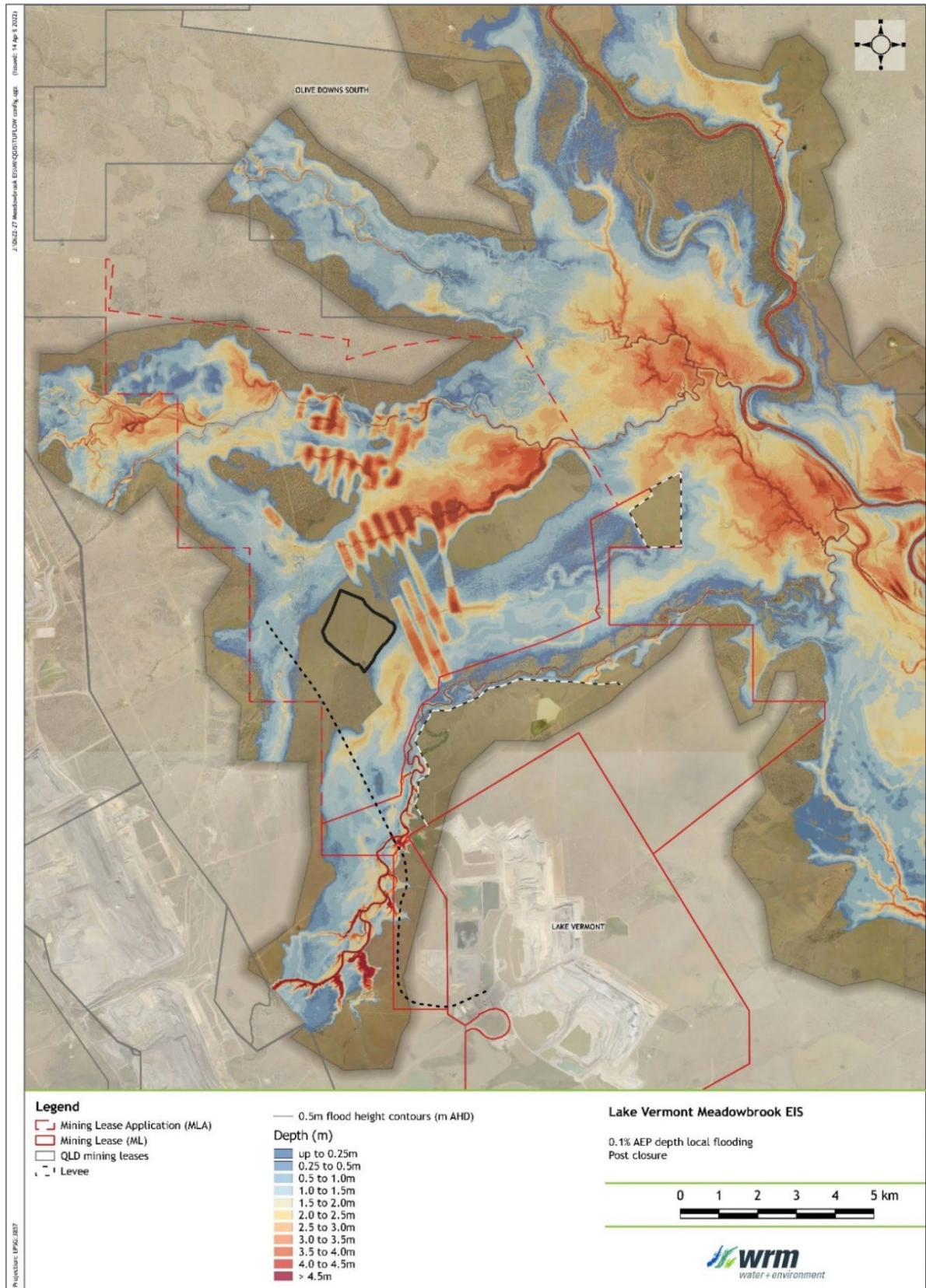

Figure 3.42: Post-closure flood model in relation to open-cut infrastructure



3.4.1.10 Waste rock management

Approximately 186 Mbcm of waste rock material is anticipated to be generated during open-cut mining. Anticipated annual waste rock volumes are provided in Table 3.7. The development of waste rock emplacements for Project Year 22 and Project Year 27 are shown in Figure 3.33 and Figure 3.34, respectively.

Two out-of-pit waste rock emplacements adjacent to the proposed open-cut pit will be required to support mining operations (Figure 3.2). A more prominent waste rock emplacement, with elevations up to 40 m above the existing surface, will be created to the west of the open-cut pit, while a smaller, temporary waste rock emplacement will be formed on the eastern boundary of the open-cut pit. As operations progress, waste rock materials (also referred to as spoil) will be placed back into the mined pit. Waste rock temporarily stockpiled in the eastern waste emplacement area will be placed back into the pit following the completion of mining.

For both the western and eastern out-of-pit waste rock emplacements, rehabilitated slopes have been designed not to exceed a grade of 1 in 7, with slope lengths at a maximum of 70 m. The final pit landform (internal) is comprised of relatively level areas and occasional short, stepped slopes of up to 1 in 7. Rehabilitation strategies and final landform details for the mine waste rock emplacements are presented in Chapter 6, Rehabilitation.

A Geochemical Assessment has been undertaken by RGS Environmental (2021) of the overburden and interburden materials (Appendix D, Geochemical Assessment). Overburden and interburden waste rock materials are geochemically similar to those materials currently produced at the existing Lake Vermont Mine. A description of the overburden and interburden geochemical and physical characteristics is provided in Chapter 15, Waste Management. In summary, the assessment has confirmed that:

- there is negligible risk of acid mine drainage;
- the salinity and sodicity of mine overburden and interburden is typical of the Rangal Coal Measures; and
- the waste rock materials are amenable to revegetation as part of rehabilitation activities.

With the implementation of the proposed management and mitigation measures described in Chapter 15, Waste Management, the waste rock produced by the Project presents a low risk of environmental harm.

3.4.1.11 Mining equipment

A provisional mine equipment fleet and estimated quantity required for Project open-cut operations is provided in Table 3.9. Makes and models of equipment are representative only of the classes and sizes of equipment proposed, and the final selection will depend on financial analysis at the time of purchase.

3.4.2 ROM coal handling and processing

3.4.2.1 ROM coal handling

ROM coal from the underground mining operations will be conveyed by the underground drift conveyor directly to a 100,000 tonne ROM coal stockpile pad located in the MIA. ROM coal from the open-cut mining operations, later in the mine life, will be hauled from the open-cut pit to a ROM coal stockpile pad at the top of the southern pit ramp.

ROM coal will be loaded from the ROM coal stockpiles onto double or triple road trains by front-end loaders. Haulage will be *via* the sealed road to the existing Lake Vermont ROM pad (Figure 3.2). The ROM coal will be fed into one or both of the two existing CHPP ROM coal hoppers, noting that one hopper is adjacent to each of the two existing CHPP modules.

Dozers will be used in conjunction with front-end loaders at the two ROM coal pads to manage the stockpiles.



Table 3.9: Major open-cut mining equipment list

Unit type	Make/model	Application	Estimated quantity
Blast hole drill	Ingersoll Rand DR460	Overburden drilling	1
Excavator –600 t	Liebherr LH 9600	Overburden excavation/loading, coal mining/loading	1
Excavator –400 t/350 t	Liebherr LH 9400/ LH 9350	Coal mining/loading	2
Haul truck—220 t	Caterpillar 793	Waste and coal haulage	6
Haul truck—180 t	Caterpillar 789	Waste and coal haulage	5
Dozer	Caterpillar D10	Dump maintenance	2
Dozer	Caterpillar D11	Face clean-up, dump maintenance, ROM coal stockpile	3
Wheel dozer	Caterpillar 854	?	2
Grader	Caterpillar 18M	Overburden contouring/road grading	2
Water cart	Caterpillar 777	Dust suppression	2
Loader	Caterpillar 992	Coal loading	2
Service truck			1
Road-train		Haulage of ROM coal from stockpile to new ROM pad	1
Light trucks			4
Light vehicles			22

3.4.2.2 ROM coal reclaim and preparation

ROM coal reclaim and preparation will follow existing processes at the Lake Vermont Mine. The CHPP modules comprise a range of components to process the coal and separate coal reject materials, including:

- crushers;
- screens;
- dense medium cyclones;
- flotation cells;
- separators;
- filters; and
- thickeners.

The CHPP was developed with two processing modules having the capability to produce two product coals—hard coking coal and PCI coal. However, in 2016, analysis of the plant reject stream identified that a scalping reprocess of the rejects could yield additional volumes of a higher ash industrial coal, thereby reducing the volume of reject material and maximising overall resource recovery and value. As such, in 2017, a third plant module was constructed and retrofitted to the existing plant, which has enabled a third product stream of



industrial coal to be scalped. The additional industrial coal retrieved equates to approximately 10% to 15% of the total product coal produced.

The primary two CHPP modules, in tandem, can process a ROM coal feed of up to 11.2 Mtpa and produce approximately 9 Mtpa of product coal. No additional CHPP capacity is required to support the proposed Project, as the current authorised limit of 12 Mtpa of ROM coal is sufficient to support the proposed Project.

The CHPP will continue to operate up to 24 hours a day, seven days a week, with a combined design capacity of approximately 800 tph of ROM feed. A description of the operation of the CHPP modules is provided below and illustrated in Figure 3.43.

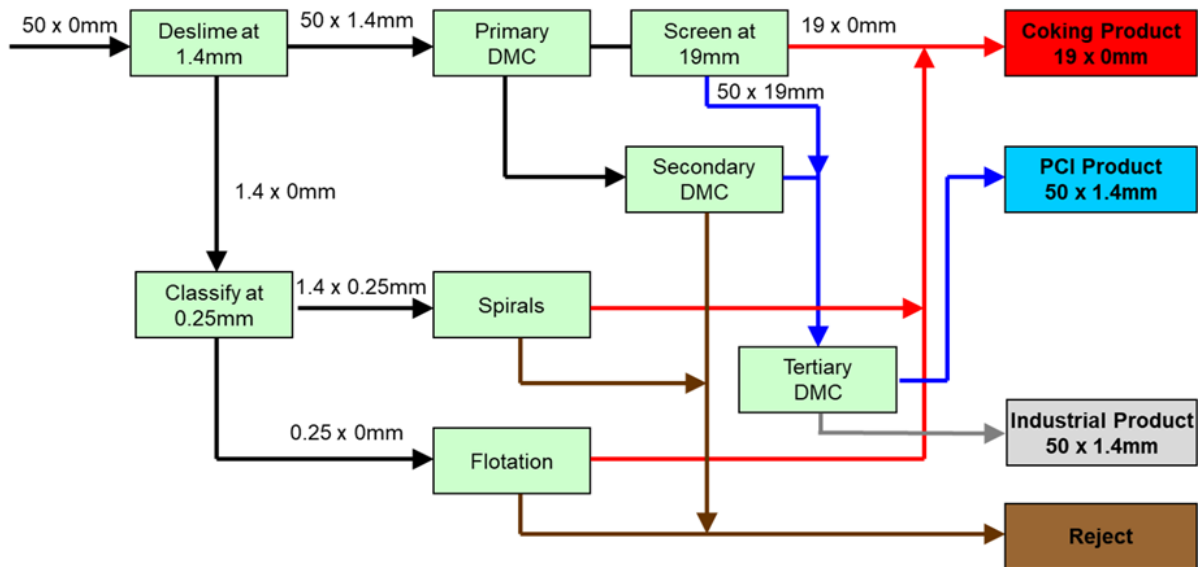

Figure 3.43: CHPP module schematic

Each ROM coal hopper dumps the ROM coal into a primary crusher with a top particle size output of 300 mm. ROM coal from the primary crusher is conveyed to secondary and tertiary crushers with top particle size outputs of 150 mm and 50 mm, respectively. Crushed coal from the tertiary crushers is fed into the raw coal surge bins. From the raw coal surge bins, the ROM coal is fed into a desliming screen with 1.4 mm aperture. Screen overflow (>1.4 mm) is fed into the coarse coal circuit, while screen underflow (<1.4 mm) is fed into the fine coal circuit.

Coal screened into the coarse coal circuit is pump fed into dense medium cyclones for separation. Metallurgical grade magnetite is used as the dense medium in the coarse coal circuit¹. Product coal from the dense medium cyclones is screened at 19 mm prior to being fed into the clean coal centrifuge before it is transferred onto the product conveyor.

Product coking coal more than 19 mm is conveyed to the coking coal stockpile to be reclaimed by the train loading system. Product coal less than 19 mm is fed into the tertiary dense medium cyclone to produce PCI product coal, which is conveyed to the PCI coal stockpile to be reclaimed by the train loading system.

Coarse rejects from the underflow of the dense medium cyclones will be conveyed to the reject crusher where they will be crushed to less than 32 mm. The coarser waste fractions (i.e. the waste from the cyclones) typically comprise up to 70% to 75% of the total coal reject stream.

Coal screened into the fine coal circuit is fed into classifying cyclones with a 0.25 mm aperture screen. Fractions more than 0.25 mm are fed into spiral concentrators, while fractions less than 0.25 mm are fed into Jameson flotation cells for fine coal beneficiation (Figure 3.43). The reagents added to the fine coal circuit

1 While magnetite is routinely recovered with 99.99% efficiency from wash water in the product coal and rejects circuit, some magnetite remains in the product coal and waste streams. Any magnetite in the waste circuit will end up in the co-disposal facilities, while material lost to the product stockpile will contribute to the mineral matter content of the product coal.



have the effect of generating fine bubbles that attract the coal particles while suppressing any general tendency for the mineral matter present to attach itself to the rising bubbles. Methyl Isobutyl Carbinol and diesel are used in the flotation process². Product coal from the spiral concentrators and flotation cells is fed into the clean coal centrifuge and then onto the coking coal product conveyor. Process water from the spiral concentrators and flotation cell circuits (containing fine rejects) is pumped as a slurry to the tailings thickener. Management of coarse rejects from the reject crusher and fine rejects from the tailings thickener is described in section 3.4.4.

3.4.3 Product coal handling and transport

As described above, once washed in the CHPP, the coal products will continue to be conveyed to the coal stockpiles west of the CHPP and adjacent to the train load-out facility (Figure 3.44). From the product coal stockpiles, coal will be conveyed to the train load-out bin. The train load-out facility comprises a four-valve reclaim tunnel and reclaim conveyor capable of dispatching coal from the site at 4,250 tph. No additional infrastructure or modifications to the existing product coal handling processes are required for the Project. The transport of Project product coal *via* rail to port is described in section 3.5.1.2.



Figure 3.44: Lake Vermont Mine infrastructure

3.4.4 Reject management

Approximately 14.8 Mt of coal reject material will be generated from underground mining activities and approximately 2.8 Mt from open-cut mining activities, which will produce a total volume of approximately 17.7 Mt of coal rejects. Annual coal reject volumes are provided in Table 3.7.

A Geochemical Assessment has been undertaken by RGS Environmental (2021) of the potential coal reject materials (Appendix D, Geochemical Assessment). A description of the coal reject geochemical and physical

² Most reagents are recovered with recycled water, with any losses confined to the fine coal product and tailings circuits. Any reagents entrained in the wastes are retained within the co-disposal facilities where microorganisms degrade the organic chemicals present.



characteristics is provided in Chapter 15, Waste Management. The results of the geochemical test work indicate that the characteristics of potential coal reject material will:

- be non-acid forming;
- be slightly alkaline to alkaline;
- have a relatively low-level of salinity; and
- have no significant metal/metalloid enrichment.

This is consistent with the characteristics of coal reject material at the existing Lake Vermont Mine.

Coal reject management procedures utilised at the existing Lake Vermont Mine will be adopted for the proposed Project. A co-disposal system (i.e. the simultaneous disposal of coarse and fine reject material) will continue to be used to manage rejects. This will commence with the Project utilising existing, approved co-disposal cell capacity at the existing Lake Vermont Mine from Project Year 1. Prior to capacity being reached within existing cells, further approval will be sought to construct additional cells adjacent to those already existing at Lake Vermont Mine. Beyond this, additional reject disposal capacity is available within approved residual voids at the Lake Vermont Mine. In-pit disposal of coal rejects may, therefore, be considered in future, subject to independent approvals.

The crushed coarse rejects (from the reject crusher) will be mixed with process water (i.e. tailings thickener underflow containing fine rejects) and pumped as a slurry to an active co-disposal facility where it will be sub-aerially deposited. The co-disposal process will result in a single homogenous mixture that, once dewatered, will form a stable solid mass that can be readily rehabilitated. The process water will be separated as decant and recycled to the CHPP. Raw water introduced to the CHPP and recycled process water from the co-disposal facilities will be routinely treated by the addition of flocculants.

The existing co-disposal facilities are regulated structures and have been designed and certified by a suitably qualified and experienced person (RPEQ) in accordance with the relevant government regulations. Lake Vermont Mine currently operates under a Mine Waste Management Plan which incorporates a tailings disposal plan, in accordance with the existing EA conditions. This Mine Waste Management Plan will be updated to detail the procedures for the management of coal rejects generated during operation of the Project.

3.4.5 Ongoing resource definition and exploration activities

The Project resource has been defined through exploration drilling and seismic surveys. During the life of the Project, exploration activities will continue to be undertaken within Bowen Basin Coal-owned tenements. This will include in-seam drilling and surface-to-seam drilling to investigate geological structures, coal quality and seam morphology. Disturbance due to exploration activities in areas not authorised to be mined will be rehabilitated in accordance with the 'Eligibility criteria and standard conditions for exploration and mineral development projects' (DEHP 2016).

3.4.6 Hazardous substances

The hazardous materials and chemicals to be used for the Project are listed in Table 3.10. Further information on hazardous materials and chemicals is provided in Chapter 16, Hazards and Safety.



Table 3.10: Indicative list of hazardous substances

Hazardous substance	DG class ¹	UN number ²	Packing group ³	Purpose/use
Acetone	3	1090	II	Degreasing agent and paint thinner
Ammonium nitrate	1.1D	0241	N/A	Explosive (for blasting)
Acetylene	2.1	1001	N/A	Welding and cutting
Chlorine	2.3 (5.1, 8)	1017	N/A	Water treatment
Diesel	3	1202	III	Fuel for vehicles and equipment, CHPP and explosives use
Liquefied petroleum gas	2.1	1075	N/A	Fuel for forklifts
Lubricant oils, grease and waste oil	9	3082	III	Transmission oils, hydraulic oils, engine oils, drive oils
Oily rags	4.2	1856	N/A	Waste product
Methyl Isobutyl Carbinol	3	2053	III	CHPP
Sodium hydroxide (caustic soda)	8	1823	II	Degreasing agent and sewage treatment
Paint	3	1263	I	Painting

¹ DG Class: Dangerous Goods class means the hazard class of the dangerous goods as stated in the Australian Code for the Transport of Dangerous Goods by Road and Rail Edition 7.7, 2020.

² UN numbers: A number that identifies hazardous substances and articles (such as explosives, flammable liquids, toxic substances, etc.) in the framework of international transport. UN numbers are assigned by the United Nations Committee of Experts on the Transport of Dangerous Goods.

³ Packaging Group: Assigned to dangerous goods (other than Classes 1, 2 and 7) according to the degree of risk the goods present (I = great danger, II = medium danger and III = minor danger).

3.4.7 Operations disturbance areas

Forecast disturbance resultant of the Project operational phase is outlined in Table 3.11. This includes disturbance associated with:

- subsidence-induced ponding;
- drainage management measures to mitigate subsidence impacts;
- gas drainage management activities; and
- open-cut mining activity.

The location of mining infrastructure has been selected to minimise vegetation clearance. Vegetation clearance procedures have been developed for the Project and are described in Chapter 10, Terrestrial Ecology.

An assessment of subsidence-induced impacts on watercourses is considered in Chapter 8, Surface Water. Impacts on environmental values resultant from subsidence is described in Chapter 10, Terrestrial Ecology, Chapter 11, Aquatic Ecology and Chapter 21, Matters of National Environmental Significance.



Table 3.11: Disturbance associated with Project operations

Operations component	Approximate disturbance (ha)
Subsidence-induced ponding impacts (post-drainage mitigation works)	213
Drainage management measures to mitigate subsidence impacts	8.3
Gas drainage management activities (new track construction)	0.5
Open-cut mining (including the flood levee and diversion drain) footprint	666.4

3.5 Infrastructure

3.5.1 Transport

3.5.1.1 Road transport

Existing road transport infrastructure in the vicinity of the Project is described in section 3.2.2.1. Vehicle access to the Project will primarily be *via* Dysart utilising the Golden Mile Road (council-controlled road) and the privately owned Lake Vermont Mine Access Road (Figure 3.12). It is acknowledged, however, that access to the Project may also be *via* an alternative route from Mackay, which is expected to be used by a minority of Project traffic. This route includes the Golden Mile Road (east of the intersection with the Lake Vermont Mine Access Road) *via* the Fitzroy Developmental Road.

The Lake Vermont Accommodation Village is in Dysart at the intersection of Queen Elizabeth Drive and the Dysart Bypass Road. The village is proposed to be refurbished and extended to provide additional rooms and alleviate ongoing car parking congestion. As indicated in section 3.1.4, these proposed works on the existing accommodation village will be subject to separate approval under the Queensland *Planning Act 2016*.

Stantec (Appendix R, Transport Impact Assessment, Section 5) has assessed the existing road transport infrastructure and potential impacts of the Project on the existing road network. No additional infrastructure requirements or upgrades are considered to be required as a result of the proposed Project. The impact assessment and proposed mitigation measures are described in Chapter 20, Transport.

3.5.1.2 Rail transport and port operations

As described in section 3.2.2.2, the existing Lake Vermont Mine has a spur line and rail loop branching off the Norwich Park Branch Railway (Goonyella Railway System) (Figure 3.2).

As the Project does not increase the annual product coal output from the Lake Vermont Mine Complex (beyond currently approved levels), there is no requirement for new rail infrastructure at the Lake Vermont Mine. Product coal from the Project will be loaded onto trains using the existing train load-out facility at the Lake Vermont Mine for transportation to port. Based on the current capacity of coal trains, the Lake Vermont Complex would continue to require an average of 15–20 train movements per week.

Project coal will be transported *via* port facilities connected to the Aurizon Goonyella Rail system. The rail system interconnects to port facilities, including Abbott Point Coal Terminal north of Bowen, RG Tanna Coal Terminal in Gladstone and the Dalrymple Bay Coal Terminal in Mackay. The existing Lake Vermont Mine product coal is transported to these port facilities for shipping to international markets.



3.5.1.3 Air transport

Mackay and Emerald Airports are the nearest major regional airports servicing the region, while Moranbah is the nearest regional airport in the vicinity of the Project. The Project workforce will utilise the existing regional air infrastructure as required.

The Project workforce will be predominantly local to the region, so the number of staff using airport facilities will not impact airport operations. Therefore, airport facilities and operations are not expected to be affected as a result of the Project.

3.5.2 Energy

3.5.2.1 Electricity supply

Existing electricity infrastructure is described in section 3.2.2.4. In summary, the Dysart substation, which is jointly owned by Powerlink and Ergon Energy, provides electricity to the Lake Vermont Mine *via* a 66 kV ETL. The Ergon Energy Vermont substation is adjacent to Lake Vermont Mine's CHPP.

As described in section 3.3.6, additional electricity infrastructure is required to provide power to the Project, including a 66 kV ETL, electrical substation, 22 kV ETL distribution network within the MIA and cables to provide electricity supply to the underground *via* surface-to-seam boreholes.

The peak permanent power demand during the Project operational period is estimated to be approximately 27 MW. The Dysart substation has sufficient capacity to supply this requirement.

Diesel-powered generators and/or solar power units will be used during the construction phase to supply electricity prior to the electricity infrastructure being developed.

3.5.2.2 Fuel supply

A diesel storage facility capable of storing up to approximately 120 kL will be established at the MIA for the refuelling of mining support and transport vehicles. All fuel storage facilities will be constructed and operated in accordance with Australian Standard (AS) 1940 'The Storage and Handling of Flammable and Combustible Liquids'. Diesel will be transported to the site by road tanker from Moranbah or Mackay.

3.5.3 Telecommunications

Telecommunications for the Project will be provided by an extension of the existing communications systems at the Lake Vermont Mine. A fibre-optic or microwave telecommunications cable will extend telecommunications from the Lake Vermont Mine to the Project MIA within the proposed infrastructure corridor. The telecommunications cable will be co-located with the proposed water and power infrastructure.

An existing telecommunications tower is located at the existing Lake Vermont Mine, with a further telecommunications tower anticipated to be constructed within the proposed MIA.

An underground phone and radio communication system will be controlled and monitored through the mine office control room.

3.5.4 Sewage treatment

During the construction phase, a primary sewage treatment process will be installed for use until the STP is operational. Septic tanks will collect liquid and sludge waste products, which will be routinely transported off-site to a local council STP for further processing and disposal. The waste sludge is expected to be removed every 12–18 months by a regulated waste contractor for disposal at a licensed facility.



An STP will be constructed within the MIA for operations. Sewage generated at the MIA will be pumped to a package STP by underground sewage pump stations and underground rising mains. The STP will have a secondary treatment capability and the ability to produce Class C effluent for irrigation. The collection system would utilise an appropriately-sized pump station to minimise the retention of raw sewage and mitigate the potential for production of odour and volatile organic compounds. All equipment and control panels will be located in a control room at the MIA. Wet weather storage will be located adjacent to the plant, with a capacity to ensure that irrigation of saturated soil is avoided during wet weather periods.

The 'Model for Effluent Disposal Using Land Irrigation' (MEDLI) software has been used by Cardno (Appendix S, Land Based Effluent Disposal Assessment, Section 8) to model the proposed irrigation of treated effluent to land. MEDLI modelling is discussed in Chapter 15, Waste Management. Through MEDLI modelling, it has been conservatively estimated that a maximum of 200 workers will be on-site at any one time and that each worker will generate their entire wastewater volume (equating to one equivalent person) of 200 L/day of effluent in accordance with the 'Environmental Protection Regulation 2019.'

The proposed irrigation area for treated effluent is shown in Figure 3.24. The area has been proposed as an effluent irrigation area because:

- it is on high ground, well away from waterways (protected by the MIA levee);
- it is close to and at a similar elevation to the primary source of wastewater; therefore, pumping requirements are minimised;
- there is sufficient space to allow for the placement of the irrigation area while maintaining adequate buffers from sensitive receptors, such as waterways, ecosystems, groundwater users and the public; and
- the area has previously been cleared and used for grazing purposes resulting in lower ecological value.

MEDLI modelling determined that an area of approximately 3.6 ha will be sufficient for irrigation, given the site characteristics, soils and vegetation of the area assessed. Treated wastewater from the STP will be disposed of using low height sprays in the designated irrigation area. The effluent disposal system will incorporate an appropriate buffer to comply with guideline requirements, and warning signs complying with Australian Standard AS 1319 will be erected.

Treated effluent will not be irrigated immediately prior to expected rainfall or if pooling of water is evident at the site to reduce the potential for runoff from the irrigation area. During these periods, treated effluent will be stored in wet weather storage tanks at the MIA. Sewage treatment and management is addressed in Chapter 15, Waste Management.

3.5.5 Water supply and management

3.5.5.1 Water supply

As described in section 3.2.2.5, Bowen Basin Coal holds a water supply agreement with Sunwater's Eungella Water Pipeline Pty Ltd for the supply of up to 1,500 ML of water per annum to the Lake Vermont Mine. Bowen Basin Coal also has an on-supply contract with Peabody to transfer Peabody's 1,000 ML per year water allocation to the Lake Vermont Mine.

There is sufficient capacity available from within the current water supply agreements to meet the anticipated requirements of the Project. Detailed water balance modelling has been undertaken for the Project and is provided in Chapter 8, Surface Water.

3.5.5.2 Water management

A detailed water management system for the Project is described in Chapter 8, Surface Water. The water management system for the Project has been designed to minimise environmental impacts on the receiving environment, as well as provide runoff containment and supply the water demands of the Project.

Water management infrastructure has been proposed to achieve separation of water types by:



- drainage diversions of clean catchment runoff around mine infrastructure and other disturbed land;
- capture and treatment of disturbed runoff in sediment basins and other sediment control infrastructure;
- containment of mine-affected water in dedicated storages; and
- protection and mitigation of flood flows by the construction of a flood protection levee.

The major components of the Project water management system are described here.

MIA and open-cut pit levees

Details on the MIA levee construction is provided in section 3.3.7.3. Details on the open-cut pit levee construction is provided in section 3.4.1.8.

Raw water supply pipeline

An extension to the existing raw water supply pipeline will be constructed within the infrastructure corridor from the existing Lake Vermont Mine (that sources water from the Eungella Water Pipeline Southern Extension) to the proposed MIA. The proposed 12 km raw water supply pipeline will transfer raw water to a Raw Water Dam at the MIA. Raw water will then be treated through a water treatment plant for use underground.

Underground mine dewatering system

Water accumulating within the underground workings (groundwater inflows, excess dust suppression water and washdown water) will be pumped to the surface to the Dewatering Dam located within the MIA. Underground dewatering is anticipated to cease in Project Year 23 (indicatively 2048) at the completion of underground operations.

Open-cut mine dewatering system

Local runoff and groundwater seepage accumulating within in-pit sumps in the open-cut mining pit will be pumped to the Dewatering Dam (replacing inflows from the underground operations).

Return water pipeline

Inflows to the underground operations and associated water management system are expected to exceed demands for mine water within the Meadowbrook operation. The return water pipeline will be used to transfer excess mine-affected water *via* the infrastructure corridor to environmental dams at the existing Lake Vermont Mine. The return water pipeline will be located within the proposed infrastructure corridor for the Project.

Potable water supply

The water treatment plant will be located within the MIA and have the capacity to treat raw water from the Raw Water Dam and pipeline at a rate of up to approximately 10 ML/year. Treated water will be stored in 180 kL capacity potable water tanks adjacent to the plant.

Wastewater produced from the water treatment plant will be captured and stored within the mine-affected water system and used for dust suppression.

Sewage treatment

Sewage generated at the MIA will be pumped to a package STP by underground sewage pump stations and underground rising mains. The STP will have secondary treatment capability and the ability to produce



Class C effluent for irrigation. It is conservatively estimated that effluent will be produced at a rate of approximately 40kL/day (based on 200 workers each generating 200 L/day of effluent on-site each day). Wet weather storage will be located adjacent to the plant, with irrigation of treated effluent proposed to occur within the MIA.

Raw water dam

The Raw Water Dam will be within the MIA and will temporarily store raw water for use when relatively high-quality water is required—for example, within the underground operations, in equipment requiring clean water for cooling, and feed water for the potable water treatment plant. The Raw Water Dam will be sized to provide continuation of supply in the event of reasonably foreseeable equipment failure (e.g. pump or pipeline failure).

MIA dam

Runoff from disturbed areas within the MIA will be contained within the levee system and directed into the Mine Infrastructure Area Dam (MIA Dam), which is proposed for the low area to the east of the ROM stockpile. Runoff captured in the MIA Dam could include runoff from the ROM stockpile, laydown areas, and workshop areas. For this assessment, it has been conservatively assumed that the MIA Dam will capture runoff from the entire area within the MIA levee. In the detailed design, the site drainage system will be configured to minimise the area captured and direct clean runoff from undisturbed parts of the MIA away from the dam.

Dewatering dam

The Dewatering Dam will be located within the MIA and store water transferred from the underground and open-cut mining operations. As overviewed in section 3.4.1.6, water from the Dewatering Dam will be pumped into the adjoining MIA Dam (for management or storage), utilised for dust suppression or sent back to the Lake Vermont Mine to support processing requirements.

The Dewatering Dam will be operated to avoid any overflows; however, emergency overflows *via* the spillway will be captured within the MIA Dam.

Sediment dams

During open-cut mining operations, catchment runoff from overburden dumps will be captured in three sediment dams (referred to as the Southern Sediment Dam, Northern Sediment Dam 1 and Northern Sediment Dam 2). Sediment dams will be designed and operated in accordance with the 'Department of Environment and Heritage Protection Guideline—Stormwater and environmentally relevant activities' (DEHP 2017). This guideline states that:

- *For events up to and including a 24-hour storm event with an ARI of 1 in 10 years, the following must be achieved:*
 - *a sediment basin must be designed, constructed and operated to retain the runoff at the site(s) approved as part of the ERA application; and*
 - *the release stormwater from these sediment basins must achieve a total suspended solids (TSS) concentration of no more than 50mg/L for events up to and including those mentioned above. For events larger than those stated above, all reasonable and practical measures must be taken to minimise the release of prescribed contaminants.*

Proposed sediment dams will, therefore, be constructed to contain a 1 in 10-year ARI 24-hour rainfall event. Northern Sediment Dam 1 would be initially constructed by pre-excavating overburden material near the northern corner of the open-cut pit levee. Once the existing ground surface is mined out, sediment dams would be formed into localised depressions north and south of the open-cut pit (refer Figure 3.27). All sediment dams will be removed and rehabilitated as part of mine closure.



3.6 Project alternatives

The Project objectives and rationale are described in section 3.1.2. The Project addresses the decline in coal output that will occur from the existing Lake Vermont Mine operations and secure the long-term future of the Lake Vermont Mine by mining the coal reserves that occur to the immediate north. The Project will enable the Lake Vermont Mine Complex to maintain its current production output of approximately 9 Mtpa for approximately 20 years over a total mine life of approximately 53 years (including final rehabilitation). This will enable the Lake Vermont Mine to continue to be a significant contributor to employment, the Dysart community, the surrounding region and state revenues.

This section describes the alternatives considered in the development of the Project. Assessment of the Project alternatives has focused on maximising resource recovery while avoiding or minimising potential environmental and social impacts.

3.6.1 Mining method alternatives

Coal deposits are mined using either open-cut mining methods or underground mining methods dependent on both technical and economic parameters. The Lake Vermont Mine operations currently utilises open-cut mining methods to extract coal from the Vermont and Leichhardt Seams due to the favourable low strip ratio. Both underground and open-cut mining methods are proposed for the Project, which are described here.

Open-cut mining

An initial assessment was made to map the economic open-cut limits beyond the approved ML boundaries but within the MDL tenements. Up to three potential small areas amenable to open-cut mining have been identified within the Project area that could operate as 'satellite' pits to the main Lake Vermont Mine. The environmental values and constraints have been assessed, and it has been determined that two of the potential open-cut areas would not be viable due to their locations within flood plain areas and the risk this may present to downstream water users in the Isaac River catchment area. The costs to completely backfill these relatively small pits would make these areas economically unviable.

However, one small open-cut area lies largely outside of flood plains and other environmentally sensitive areas and provides a longer-term extension that can be mined towards the end of the Lake Vermont open-cut mine life. This area provides an additional 13 Mt of potentially recoverable coal resource (Table 3.5). The seams within the identified open-cut footprint, however, are relatively steeply dipping.

Given the dip of the seams and the small resource base, dragline methods are considered unsuitable. Based on the seam dips, terrace mining has been deemed the most applicable mining methodology. This resource has, therefore, been proposed for mining and is identified as the Project's open-cut satellite pit.

Underground mining

Within the underground resource area, two target seams have been identified that provide a working section thickness amenable to underground mining. As identified in section 3.4.1.1, the Vermont Lower Seam extends across the whole underground footprint, whereas the Lower Leichhardt Seam only extends across the northern half of the underground area. Within the limits of the underground footprint, the seams range in depth from approximately 150 m to 500 m.

Both Bord and Pillar and Longwall mining methods have been assessed from a technical and economic standpoint.

Utilising longwall mining, it is possible to extract the Vermont Lower Seam and Lower Leichhardt Seam in the northern section of the proposed underground mine.



Bord and pillar

First workings only bord and pillar mining methods were considered. Full pillar extraction was dismissed primarily due the elevated potential underground safety risks and the Queensland regulatory restrictions pertaining to these potential safety implications.

Economic Bord and Pillar mining relies heavily on maintaining high productivity, which is achieved by maximising face cutting time and minimising interruptions to the coal cutting process—the primary interruption to coal cutting is the requirement to install roof and roadway support. A cutting method, known as Cut and Flit or Place Changing, enables the coal cutting sequence to be divorced from the roof support sequence and thereby maintain high productivity. The method is reliant on the temporary self-supporting nature of the immediate face area. As depth increases, the required support density increases, which ultimately requires immediate roof support that reduces the time available for cutting. Typically, economic Bord and Pillar mining is generally limited to depths less than 250 m to 300m.

Based on using a 250 m depth limitation across the underground resource area within the Project, only the southern, shallower portion of the Vermont Lower Seam can be accessed by Bord and Pillar mining. Applying appropriate pillar and roadway dimensions based on geotechnical assessment (Appendix A, Subsidence Assessment, Section 3), the total recoverable coal using this mining methodology would only equate to approximately 12 Mt of ROM coal. A nominal sized Bord and Pillar operation utilising two to three continuous miner units could produce between approximately two to three Mtpa of ROM coal. This would equate to an underground mine life of between four to five years. This alternative does not provide the annual production volume required or a suitable mine life extension. It also results in a very low resource recovery and potentially sterilises significant underground resources.

Longwall

A longwall mining system allows for the extraction of both the underground target seams across the full depth range within the identified underground mining footprint.

Based on the structural geology, geotechnical and other key mining parameters, plus recognising the overall environmental values and constraints, a range of longwall mine layouts and mining sequence options have been evaluated. The outcomes from this evaluation process are summarised below:

- Seam access from a completed open-cut highwall at the southern extremity of the underground footprint is not practical and results in constraints on future underground output.
- A seam access point centrally located along the western boundary of the underground footprint results in an optimal, lowest operating cost mine layout, and provides for a surface MIA located clear of flood plains and sensitive environmental constraints.
- Extraction of the two underground target seams is technically and economically viable and enables maximum resource recovery and maximum mine life.
- Maintaining production capacity by supplementing reduced open-cut production with underground production and utilising the existing CHPP and train load-out facilities will significantly reduce the magnitude of the overall future environmental impact.

3.6.2 Longwall mining layout and alternatives

During Project feasibility studies, various longwall mine layouts and scheduling alternatives have been evaluated taking due consideration of structural geology, geotechnical aspects, key mining parameters, predicted subsidence and potential impacts on environmental values. The steps included:

- preliminary subsidence modelling to identify potential subsidence effects resulting from various layout options and the interactions from mining both the Vermont Lower Seam and Leichhardt Lower Seam;



- preliminary hydrologic and hydraulic assessment of the various options to identify the potential extent and magnitude of impacts on surface water flows (e.g. identifying whether the impacts resulting from alternative panel orientations is material);
- adoption of a mine layout that minimises impacts on environmental values; and
- maximising resource recovery, production output and economic return.

Two conceptual mine layouts were initially considered, with the panels at different orientations. In one option, the panels were aligned in a generally north–south orientation, perpendicular to Boomerang Creek and One Mile Creek. In the second option, the panels were aligned east-west, generally parallel to the watercourses. For each option, further alternatives were assessed in which only the Vermont Lower seam was mined, or both the Vermont Lower seam and Leichardt Lower seam were mined.

The preliminary subsidence and hydrological assessments indicated that an underground mining longwall layout with an approximate north–south orientation would best minimise subsidence effects and impacts on key environmental values (particularly watercourses). This general panel orientation would also provide good alignment with respect to the structural geology and geotechnical characteristics. The assessments also indicated that subsidence impacts on Phillips Creek would be minimised if the longwall panels that extend to the south in the underground mining area were offset from this watercourse.

An assessment of options to mitigate areas of residual ponding (post-subsidence) was also undertaken, resulting in the mitigation drains and bunds proposed for the Project. The proposed mitigation works will minimise the duration of any residual ponding by draining the ponded water away as soon as downstream water levels allow.

The underground roadway design, panel orientation and seam access for the Project also included consideration of the following key parameters:

- structural geology and coal quality;
- ground control (i.e. geotechnical stability and characteristics of the underground mining area);
- optimisation of roadway development to longwall extraction tonnes;
- personnel and materials management (i.e. access to/from the underground mining area);
- ventilation and gas management; and
- mining sequence.

The overall assessment process showed that a centrally-located set of main headings oriented east to west with a longwall panel oriented approximately north to south either side of the main headings will provide the most effective mine layout with minimum environmental impact.

3.6.3 Open-cut mining layout and sequence

The location of the Project is primarily defined by the existing Lake Vermont Mine and the coal reserves within MDL 429 and MDL 303. At the time of the Initial Advice Statement for the Project (AARC 2019), the mining of three open-cut satellite pits was proposed. Two of the satellite pits were subsequently removed from the proposed Project in consideration of environmental and economic impacts. Removing the two satellite pits from the Project has resulted in a reduction in the amount of remnant vegetation proposed to be cleared.

An assessment of various open-cut pit layout and sequence options have been undertaken for the remaining open-cut satellite pit to minimise environmental impacts. Option analysis has indicated the satellite pit could be mined in such a way (initially from the south, and then from the north) that the partially backfilled pit could be located outside of the floodplain post-mining. Options assessed for the layout of the open-cut pit also indicated the open-cut pit could be mined to largely avoid the requirement to clear remnant or high regrowth vegetation. Amendments to the open-cut pit layout have been made to the original pit extent to minimise potential impacts. Potential impacts of the open-cut pit on ecological values are assessed in Chapter 10, Terrestrial Ecology and Chapter 21, Matters of National Environmental Significance.



Mined material that does not contain economic coal is termed waste rock. Waste rock is usually disposed of in the open-cut void and/or waste rock emplacements and progressively rehabilitated. Options considered for disposal of Project waste rock from the open-cut include:

- disposal of mine waste rock material in permanent out-of-pit waste rock emplacements;
- storage of mine waste rock material in temporary out-of-pit mine waste rock emplacements followed by rehandling of mine waste rock to backfill the open-cut; or
- a combination of permanent out-of-pit mine waste rock emplacements and temporary out-of-pit mine waste rock emplacements, together with open-cut backfilling.

The final option has been selected for the Project, as it allows for the overall disturbance footprint to be minimised, while also allowing for progressive rehabilitation of mine landforms.

3.6.4 Infrastructure corridor alignment

Various alignment options for the infrastructure corridor have been assessed in consideration of safety, environmental and existing Lake Vermont Mine operational requirements. The raw water and mine water pipelines, the ETL and telecommunications infrastructure have been co-located with site access to the MIA to reduce the cumulative surface disturbance that would occur with individual alignments.

Alignment options considered include:

- the location at which the infrastructure corridor traverses Phillips Creek and One Mile Creek in consideration of the floodplain and required stream crossing design;
- whether the proposed infrastructure corridor would extend to the CHPP reclaim hoppers or to a new ROM pad area further north at the Lake Vermont Mine (and thereafter be transported *via* the existing haul road to the CHPP reclaim bins);
- the location of the western access road in consideration of site topography and existing Lake Vermont Mine operational requirements; and
- various configurations for access to the MIA area in consideration of existing infrastructure and Project requirements such as power, water and telecommunications.

The proposed alignment of the infrastructure corridor has been selected to:

- minimise the crossing length and proposed disturbance to Phillips Creek and One Mile Creek;
- traverse higher ground to minimise the extent of the infrastructure corridor traversing the floodplain;
- minimise the amount of remnant vegetation required to be disturbed;
- minimise disturbance to environmentally sensitive areas (such as habitat for threatened species and communities) in consideration of infrastructure requirements within the MIA area (e.g. power supply from the infrastructure corridor to the proposed electrical substation); and
- facilitate the integration of ROM coal haulage with the existing operations.

The location of the proposed infrastructure corridor is shown in Figure 3.2.

3.6.5 Infrastructure and MIA

The primary objective of the Project is to maintain currently approved production levels at the Lake Vermont Mine and address the future marked decline in output from the existing operation. The Project maximises the use of current infrastructure, which will minimise the additional infrastructure that is required. This will provide environmental and economic benefits by reducing the overall footprint of the proposed extension and the capital expenditure.



The existing infrastructure at the Lake Vermont Mine that will be utilised includes:

- existing roads/mine haul roads;
- CHPP;
- rejects co-disposal cells;
- train loading facilities;
- rail loops; and
- connections to raw water, power and telecommunications.

No additional CHPP capacity will be required, as with the current authorised limit of 12 Mtpa of ROM coal, the plant will have sufficient capacity to support the proposed Project. Similarly, no additional rail or port capacity is required, as the volume of coal to be transported *via* the rail network will be within existing commercial arrangements.

The location of the MIA has been chosen to:

- avoid the sterilisation of coal resources;
- be proximate to underground and open-cut mining activities;
- be at an appropriate distance from open-cut pit blasting activities.
- avoid the clearing of remnant vegetation or, where this is not practicable, it must minimise the clearance of remnant vegetation as much as possible;
- avoid disturbing the habitat of threatened species and threatened ecological communities known to occur or have the potential to occur or, where this is not practicable, it must minimise the area required to be disturbed as much as possible;
- avoid or minimise exposure of infrastructure to flooding; and
- have a relatively flat topography to minimise the earthworks required.

Threatened ecological communities and species known to occur include the:

- Poplar Box Threatened Ecological Community;
- Brigalow Threatened Ecological Community;
- Ornamental Snake;
- Squatter Pigeon;
- Koala; and
- Greater Glider.

Detailed mapping of these communities and species' habitats has also been considered in all aspects of mine planning. This has maximised the potential to avoid and/or minimise disturbance to these habitats.

In light of these considerations, the most appropriate location of the MIA is ultimately considered to be on the western boundary of the Project site, as shown in Figure 3.2.

3.6.6 Workforce accommodation

Workforce accommodation options for the Project include:

- self-accommodation (i.e. live locally in their own home);
- rental accommodation;



- utilisation of existing accommodation villages in Dysart; and
- utilisation of the existing Lake Vermont Mine Accommodation Village.

Local communities are defined as including communities located within a one-hour drive of the Project. This represents locations where the potential workforce might reside locally, having regard to limitations on travel distances and fatigue management requirements. Dysart is the only town located within an hours' drive of the Project site.

Bowen Basin Coal initially considered an expansion of the Lake Vermont Accommodation Village to accommodate both the construction and operational workforces. However, this would require a significantly higher number of rooms to be constructed than would ultimately be required for operational years. Instead, the Project proposes to utilise the existing commercial accommodation village facilities in Dysart for the construction workforce. The construction workforce will be accommodated in either the commercial *Civeo* accommodation village or the *Stayover by Ausco* accommodation village in Dysart, both of which have sufficient capacity to provide for the Project construction workforce. The use of existing villages in Dysart for the construction workforce has been selected to minimise the potential environmental, social and economic impacts of the Project.

The accommodation strategy for the Project has been developed to encourage workers to live locally, as described in section 3.1.7.6. Consultation with the IRC has indicated the Lake Vermont Mine Accommodation Village in Dysart is the preferred location to continue to accommodate the operational workforce for the Lake Vermont Mine Complex (i.e. the workforce from Project Year 1 onwards) who do not choose to live locally. Jellinbah Group (a related entity of Bowen Basin Coal) has acquired land adjacent to the Lake Vermont Accommodation Village to enable the village to be extended by up to an additional 100 rooms with additional car parking. The extension will facilitate a progressive refurbishment of the existing facilities and ease congestion issues at the current village, as discussed in section 3.1.7.6.

3.6.7 Not proceeding with the Project

In accordance with the ToR, an assessment of the consequences of not proceeding with the Project has been conducted. Were the Project not to proceed, the following consequences are inferred:

- The output from the existing Lake Vermont Mine will markedly decline beyond 2028 and result in a direct loss of approximately 410 workers over a period of 20 years. This will result in flow-on impacts (both direct and indirect) to the local Dysart community and the surrounding regional economy.
- Alterations to current land use practices would not occur.
- Approximately 122 Mt of ROM coal would not be mined, resulting in a loss of mining royalties.
- There would be a loss of State and Federal tax revenue. Over its life, the Project is estimated to provide approximately \$1,919.4 million of additional tax revenues to the Australian Government, and approximately \$1,334.5 million to the Queensland Government as compared to what would occur without the Project.

3.7 Ecologically sustainable development

Ecologically Sustainable Development (ESD) is defined by the Australian government's 'National Strategy for Ecologically Sustainable Development' (1992) as:

Using, conserving and enhancing the community's resources so that ecological processes, on which life depends, are maintained, and the total quality of life, now and in the future, can be increased.

The core objectives of the strategy are to:

- Enhance individual and community wellbeing and welfare by following a path of economic development that safeguards the welfare of future generations.
- Provide for equity within and between generations.



- Protect biological diversity and maintain essential ecological processes and life-support systems.

While the guiding principles of the strategy are:

- Decision-making processes should effectively integrate both long- and short-term economic, environmental, social and equity considerations.
- When there are threats of serious or irreversible environmental damage, lack of full scientific certainty should not be used as a reason for postponing measures to prevent environmental degradation.
- The global dimension of environmental impacts on actions and policies should be recognised and considered.
- The need to develop a strong, growing and diversified economy that can enhance the capacity for environmental protection should be recognised.
- The need to maintain and enhance international competitiveness in an environmentally sound manner should be recognised.
- Cost-effective and flexible policy instruments should be adopted, such as improved valuation, pricing and incentive mechanisms.
- Decisions and actions should provide for broad community involvement on issues which affect them.

The principles of ESD are reflected in the EPBC Act and EP Act and are to be taken into account by the commonwealth minister and the Queensland chief executive, respectively, when deciding whether or not to approve the Project.

Section 3A of the EPBC Act includes the following principles of ESD:

- a) decision-making processes should effectively integrate both long-term and short-term economic, environmental, social and equitable considerations;*
- b) if there are threats of serious or irreversible environmental damage, lack of full scientific certainty should not be used as a reason for postponing measures to prevent environmental degradation;*
- c) the principles of inter-generational equity – that the present generation should ensure that the health, diversity and productivity of the environment is maintained or enhanced for the benefit of future generations;*
- d) the conservation of biological diversity and ecological integrity should be a fundamental consideration in decision-making; and*
- e) improved valuation, pricing and incentive mechanisms should be promoted.*

ESD is defined under the EP Act as follows:

*...development that improves the total quality of life, both now and in the future, in a way that maintains the ecological processes on which life depends (**ecologically sustainable development**).*

Reflective of the definitions and principles above, the principles of ESD, including the precautionary principle, principle of intergenerational equity, conservation of biological diversity and ecological integrity and improved valuation and pricing of environmental resources have been considered in all phases of Project design and the environmental impact assessment. Section 3.7.1 to section 3.7.4 describe the consideration and application of the principles of ESD for the Project. The Project would be undertaken in accordance with the principles of ESD.

3.7.1 Precautionary principle



The application of the precautionary principle prevents an environmental threat being dismissed in a decision-making process because the scientific evidence of that threat is inconclusive. For the principle to apply, two thresholds must be met:

- 1) there must be a threat of serious or irreversible environmental damage; and
- 2) there must be a lack of full scientific certainty as to the nature and extent of the threat.

In respect of the Project, an extensive range of measures have been adopted during the planning and design phases to ensure that potential for serious and/or irreversible damage to the environment is minimised. As discussed below, these measures include detailed technical environmental assessments. In addition, for key Project environmental assessment studies, peer review by recognised experts was undertaken.

There are impacts which will inevitably be caused to the environment, and accordingly an objective and comprehensive impact assessment methodology has been undertaken to understand the nature and extent of impacts, the consideration of impact avoidance and mitigation strategies in the design phase, and identification of adaptive management plans and offsets to ensure any variability associated with those impacts can be managed with a high degree of confidence. The specialist assessments evaluating the potential for harm to the environment associated with the development of the Project has therefore reduced the level of uncertainty associated with the potential impacts from the Project.

As set out below, preventative measures are proposed to be taken including the implementation of numerous environmental management plans.

The Project has adopted and will implement a range of internal and external codes of practice, guidelines and standards in relation to environmental management, occupational health and safety and rehabilitation. Consultation with government, landholders and stakeholders has also been undertaken and has informed the preparation of the EIS.

A Hazards and Safety Assessment has been undertaken for the Project to identify Project-related risks and develop appropriate mitigation measures and strategies. The assessment considers both on-site and off-site risks to people, property and the environment (in the presence of controls) and is included in Chapter 16, Hazards and Safety.

Potential short-term, long-term and cumulative impacts have been assessed by qualified professionals to determine the likelihood of environmental degradation and irreversible impacts. In the preparation of this EIS, air quality (inclusive of greenhouse emissions), surface water, groundwater, socio-economic, transport, climate, aquatic and terrestrial ecology, noise, soil and land, cultural heritage and visual amenity have been assessed. Risk and uncertainty have also been taken into account through the conduct of sensitivity and uncertainty analysis. For example, the Surface Water Assessment (Appendix F, Surface Water Assessment, Section 4.1.2) included the assessment of climate change projections (described further in Chapter 3, Climate) and the Groundwater Assessment used the climate change scenario predictions for its groundwater modelling (Appendix E, Groundwater Impact Assessment, Section 5.6.2).

In response to these assessment findings, a series of environmental management and monitoring programs, avoidance actions, mitigation measures and environmental offsets have been proposed to adequately address the predefined risks. Contingency protocols have also been considered in the design, operational and rehabilitation phases.

Peer reviews have been undertaken by recognised technical experts regarding

- Subsidence Assessment;
- Groundwater Modelling and Assessment; and
- Surface Water Assessment (for both Geomorphology and Water Balance elements).

The peer reviews are provided in Attachments 5 to 8, respectively.



3.7.2 Intergenerational equity

Intergenerational equity is defined in the 'Intergenerational Report Australia in 2055' (Commonwealth of Australia 2015a), as:

The choices today enacted build a strong and resilient economy that will lay down the foundation for future prosperity.

In particular, intergenerational equity seeks to ensure the health, diversity and productivity of the environment is preserved to enable this prosperity for future generations. The principles of intergenerational equity have been addressed for the Project through:

- assessment of the Project's contribution to climate change and greenhouse gas emissions, and assessment of the impacts on climate change to potential Project impacts;
- consideration of potential short-term, long-term and cumulative impacts on air quality (inclusive of greenhouse emissions), surface water, groundwater, social, economic, transport, climate, aquatic and terrestrial ecology, noise, soil and land, cultural heritage and visual amenity in the preparation of this EIS; and
- development of monitoring programs, avoidance actions, mitigation measures and biodiversity offsets to adequately address the potential impacts.

Consideration has been given to the increase in social welfare, wellbeing and infrastructure that arises from an increase in economic activity. Benefits are realised by the employment, regional business opportunities and from export earnings and royalties for current and future generations.

3.7.3 Conservation of biological diversity and ecological integrity

Biological diversity refers to the diversity in three states:

- 3) gene variation (within a population);
- 4) species variation (between populations); and
- 5) ecosystem diversity (different habitat and communities present).

Comparatively, ecological integrity can be defined as the resilience of an ecosystem to maintain functional ecosystem health with a diverse range of species and habitat present.

Assessments of ecological values are described in Chapter 10, Terrestrial Ecology, Chapter 11, Aquatic Ecology and Chapter 21, MNES.

A total of 188 flora species have been recorded during the field surveys, presenting 58 families and 133 genera. Some 35 introduced flora species have also been recorded. The field-validated vegetation mapping has identified communities that are consistent with two threatened ecological communities listed under the EPBC Act, as well as vegetation communities that are listed as Endangered or Of Concern under the NC Act.

A total of 167 native species of terrestrial vertebrate fauna have been recorded during the field surveys, as well as eight introduced species. Native species recorded include:

- 11 amphibians;
- 19 reptiles;
- 109 birds; and
- 27 mammals.



Several conservation significant fauna species listed under the EPBC Act and/or NC Act have been identified in the study area during the field surveys, including the:

- Ornamental Snake
- Squatter Pigeon
- Greater Glider; and
- Koala.

Land clearance is listed as a key threatening process under the EPBC Act. The location of Project infrastructure has been selected to avoid or minimise disturbance to remnant vegetation and environmentally sensitive areas. The proposed underground mining methods provide environmental benefits by considerably reducing the extent of direct disturbance associated with the Project. The underground longwall mining layout adopted has also been selected to minimise impacts on environmental values, and the longwalls have been offset from Phillips Creek to avoid subsidence impacts to the watercourse.

Loss of climatic habitat caused by anthropogenic emissions of greenhouse gases is also listed as a key threatening process under the EPBC Act. Greenhouse gas emissions associated with direct emission sources (Scope 1) (e.g. the use of fixed and mobile plant and fugitive coal seam gas emissions), indirect emission sources (Scope 2) (e.g. the use of electricity) and other indirect emissions (Scope 3) (e.g. burning of coal in international power stations for steel production) have been assessed for the Project by Katestone (2022) (Appendix L, Air Quality and Greenhouse Gas Assessment, Section 4). The Project greenhouse gas emissions have been included in the economic valuation of the Project by AEC Group (Appendix Q, Economic Impact Assessment, Section 8.2). Valuation of the Project is discussed in section 3.7.4

Commonwealth and State Government guidelines have been used to assess the potential for significant residual impacts on matters of national and state significance. A range of measures will be implemented to maintain or improve biodiversity values of the region, including impact avoidance, minimisation, mitigation and provision of offsets (for residual impacts). The provision of offsets for the Project complies with the EPBC Act and EO Act.

In accordance with ESD principles, the Project addresses the conservation of biodiversity and ecological integrity by proposing an environmental management framework designed to conserve ecological values where practicable and providing for environmental offsets where residual impacts occur.

3.7.4 Valuation

An Economic Impact Assessment has been undertaken for the Project and is provided in Appendix Q. The Economic Impact Assessment incorporates environmental values *via* direct valuation when practicable (for example, vegetation clearance and greenhouse gas emissions).

Greenhouse gases directly generated by the Project (Scope 1 emissions) on average are estimated to be approximately 305.21 kt CO₂-e per year, while indirect emissions (Scope 2) associated with the on-site use of electricity are estimated on average to be 43.26 kt CO₂-e per year (Appendix L, Air Quality and Greenhouse Gas Assessment, Section 4.5). The Project is estimated to contribute an average of approximately 348.5 kt CO₂-e per year, which exceeds the 25 kt threshold outlined in the NGER Act, requiring Bowen Basin Coal to report to the NGER system. Scope 3 emissions are attributable to the locations where coal is consumed, rather than the Project (refer Appendix V, Climate Change Assessment). The total Scope 1 and Scope 2 GHG emissions in 2020 and 2021 from Australian corporations that had to report to NGER was 554.36 Mt CO₂-e (Clean Energy Regulator 2019). Under the Kyoto Protocol Accounting Framework, the total emissions in 2019 from Queensland was 148.22 Mt CO₂-e (DoEE 2019a). Based on the highest emissions year, the Project will generate approximately 0.88 Mt CO₂-e, representing 0.16% of Australian NGER emissions and 0.60% of Queensland emissions for the modelled worst-case scenario.

The Net Present Value (NPV) of the Project has been estimated by AEC Group (Appendix Q, Economic Impact Assessment, Section 8.3) as the difference between the present value (PV) of future benefits and PV of future



costs (Appendix Q, Economic Impact Assessment, Section 8.3). A Cost–Benefit Analysis for the Project shows that the NPV of the Project to the Queensland economy is estimated at \$968.2 million.